



C.E.I.P. San Antonio Abad (Cartagena)

Leo, leo...

¡ El león!

Cartilla



Nombre:

Ana Alonso Castelo, M^a Dolores Fernández Seguí, M^a Soledad Blanco Ramos y Josefa Pareja Sánchez z. Las autoras de este método de lectoescritura maestras del CEIP San Antonio Abad, de Cartagena, y con una dilatada experiencia en las áreas de referencia, han trabajado en una observación permanente y un análisis continuo de los cambios que se estaban produciendo entre la población escolar. Y decididas a aportar el resultado de lo que habían ido investigando, elaboraron y fueron poniendo en práctica una metodología caracterizada por algo, para ellas, muy importante, el aprendizaje significativo.

Publicaciones recientes de la Consejería de Educación, Cultura y Universidades

www.educarm.es/publicaciones

- [Unidad didáctica "Somos artistas". Educación Infantil / Ana M^a Redondo Rocamora, Ángeles Gallardo González y Juana M^a García Soto](#)
- [Poncho. El niño que quiso ser hada / Juan Pedro Gómez](#)
- [Análisis de la evolución del alumnado, profesorado, inversión y resultados de las enseñanzas de régimen general desde el curso 2000-2001 al curso 2010-2011 / Josefa Moreno Molero](#)
- [Las ideas previas del concepto "industria" en el alumnado de Geografía de 3º de la ESO / Carlos Martínez Hernández](#)
- [Guía práctica de higiene postural para docentes / Pablo Ortega Cañavate y Alicia Carrillo Cayuela](#)
- [En mi verso soy libre : relatos 2014 / Certamen Nacional de Relatos \(7º. 2014. Murcia\)](#)
- [Manuel Rivas Barrós "Todo es silencio" guía de lectura / Laura Peñafiel Vera, Vicente Roca Conesa, Fulgencia Martínez Sánchez](#)
- [Vicente Luis Mora "Alba Cromm" guía de lectura / María José Benítez Castejón, Nora Bravo Poyato, Juan de Dios García Gómez, Antonio Jiménez Morata, Antonia Hernández Rosique, María Martínez Morales](#)
- [Lola Beccaria "Zero" guía de lectura / María Teresa Ansó Vela, Leticia Jiménez Ayala, Isabel Olivo, Antonio Parra Sanz, José Antonio Parra, Eugenia Pérez Zarauz, Susana Villa Basalo](#)
- [Alfredo Gómez Celdrá "El rostro de la sombra" guía de lectura / M^a Teresa Ansó Vela, Leticia S. Jiménez Ayala, Isabel M^a Olivo Moreno, Antonio Parra Sanz, José Antonio Parra Moreno, Eugenia Pérez Zarauz, Susana Villa Basalo](#)
- [David Fernández Sifres "El faro de la mujer ausente" guía de lectura / Ana M^a Bragulat Zaplana, Consuelo Cañavate Ros, M^a Dolores Cascales Jaranay](#)

Leo, leo...

¡El león!

Cartilla

Textos:

Ana Alonso Castelo

Ilustraciones:

M^a Dolores Fernández Seguí

M^a Soledad Blanco Ramos

Josefa Pareja Sánchez

Coordinación y maquetación:

M^a Dolores Fernández Seguí



Región de Murcia
Consejería de Educación,
Cultura y Universidades



Región de Murcia
Consejería de Educación,
Cultura y Universidades

Edita:

© Región de Murcia

Consejería de Educación, Cultura y Universidades

Secretaría General. Servicio de Publicaciones y Estadística

www.educarm.es/publicaciones

Creative Commons License Deed



La obra está bajo una licencia Creative Commons License Deed. Reconocimiento-No comercial 3.0 España.

Se permite la libertad de copiar, distribuir y comunicar públicamente la obra bajo las condiciones de reconocimiento de autores, no usándola con fines comerciales. Al reutilizarla o distribuirla han de quedar bien claros los términos de esta licencia.

Alguna de estas condiciones puede no aplicarse si se obtiene el permiso del titular de los derechos de autor.

Nada en esta licencia menoscaba o restringe los derechos morales del autor.

© Textos: Ana Alonso Castelo

© Ilustraciones: M^a Dolores Fernández Seguí, M^a Soledad Blanco Ramos y Josefa Pareja Sánchez

I.S.B.N.: 978-84-697-1817-9

1^a Edición, febrero 2015

JUSTIFICACIÓN DEL PROYECTO

Ante la realidad que presenta nuestro alumnado y teniendo en cuenta sus necesidades y características, surge este proyecto basándonos en nuestra larga experiencia. Con él se pretende:

- a. Trabajar todos los aspectos del lenguaje escrito: grafía, lectura, comprensión lectora, estructuración de frases, juegos, etc.
- b. Aumentar el vocabulario de un alumnado con escaso dominio del castellano.
- c. Que el alumnado trabaje con autonomía y a su propio ritmo.
- d. Que sea asequible para las familias, ya que muchas de ellas tienen grandes dificultades económicas.

RECOMENDACIONES METODOLÓGICAS

El material es una herramienta para la enseñanza de la lectoescritura y por tanto lo podemos usar de la forma que más nos interese. Sin embargo incluyo aquí algunas sugerencias para sacarle el mejor resultado posible:

- Empezar presentando al gran grupo cada fonema, poniendo especial atención en la discriminación auditiva y en la correcta direccionalidad de la grafía.
- Leer, escribir y reconocer palabras que incluyan dicho fonema. Debemos explicar siempre el significado de las palabras nuevas y asegurarnos las entienden y las incorporan a su vocabulario.
- Una vez que se ha explicado el trabajo a realizar al conjunto de la clase debemos pasar al trabajo individual a fin de potenciar la autonomía personal de cada alumno.
- Los dictados no están incluidos con el fin de ahorrar espacio, pero son muy útiles en la enseñanza de la lectoescritura siempre que sean previamente preparados.
- Corregir inmediatamente el trabajo para que el aprendizaje sea significativo.

CEIP San Antonio Abad



CARTAGENA

Leo, leo...

¡EL LEÓN!



Nombre:



El presente trabajo es un proyecto concebido y llevado a cabo por un grupo de profesoras del CEIP San Antonio Abad de Cartagena. Todas llevamos ya muchos años en la enseñanza y hemos visto como ha ido cambiando de unos años acá el perfil de nuestro alumnado. Y coincidimos en que, dadas las características de nuestros actuales alumnos, no encontramos un método de lecto-escritura que se adapte a sus necesidades. No queremos decir con ello que los métodos existentes en el mercado no sean válidos. Hay muchos y muy buenos, pero están pensados para niños españoles que, en la mayoría de los casos, han aprendido a leer en Infantil.

No es este nuestro caso. Muchos de nuestros alumnos provienen de países no hispano-parlantes. Son familias de inmigrantes que a menudo van llegando a lo largo del curso y que suelen tener un poder adquisitivo muy limitado.

Por ello nos planteamos elaborar nuestro propio método de lecto-escritura del que “Leo, leo...El león” es la cartilla de iniciación que se complementa con una serie de cuadernillos: “El león escribe”.

Hemos intentado hacerlo con mucho apoyo gráfico a fin de aumentar el vocabulario de los niños y no hemos empleado el color para que el costo resulte lo más asequible posible, aun sabiendo que esto limita el atractivo del trabajo.

Por último hay que decir que la mayoría de las imágenes las hemos obtenido de Internet, con licencia *creative commons*, y las hemos combinado y manipulado para adaptarlas a lo que necesitábamos. Con todo, en ocasiones nos hemos tenido que poner a dibujar. Todo sea por los niños.

Noviembre de 2012

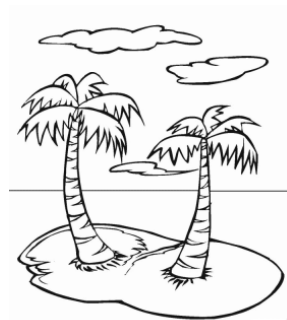
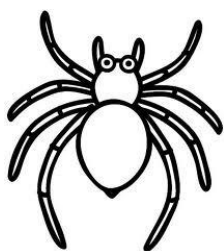

A a

E e

I i

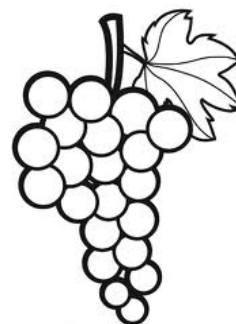
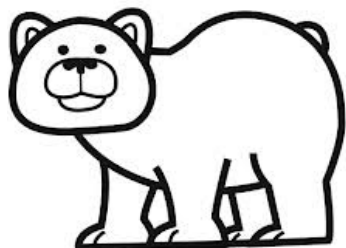

O o

U u

o i e u a e

ae eo ia ue ua ie

EO AU IA UE OE

EIA UIA EAO EIO



¡Oée, oé, oé, oée!

¡Auuuuu!

¡Ay, ay, ay!

¡Ea, ea, ea!

L l

la le li lo lu

La Le Li Lo Lu



ola



ala



Lola



lío

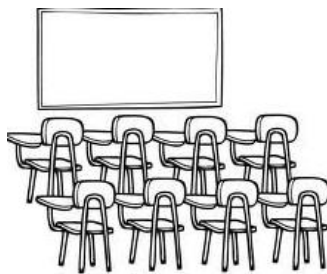

aula



ele



Leo



lila



Elia



Lola lee.

Leo lía.

Elia olía la lila.

La ola, la lila y el aula.

P p

pa pe pi po pu

Pa Pe Pi Po Pu



papá



Pepe



apio

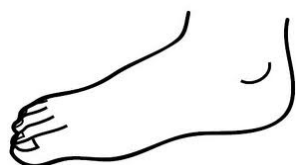

pie



lupa



pupa

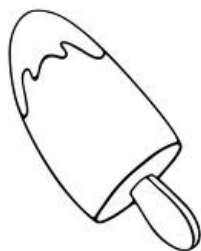

polo

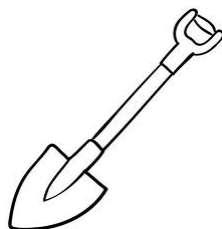

pala

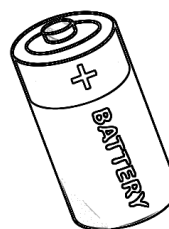

pila

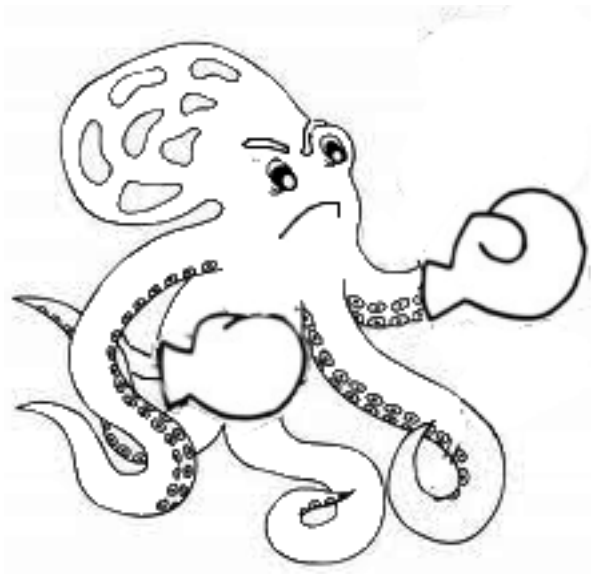

El pulpo pelea.

La lupa y el papel.

Pili oía a Pio.

Pepe pela a papá.

S s

sa se si so su

Sa Se Si So Su



oso



Susi



sopa



seis



sol

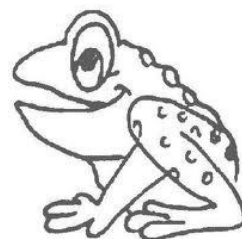

sapo



peso



sala



pipas

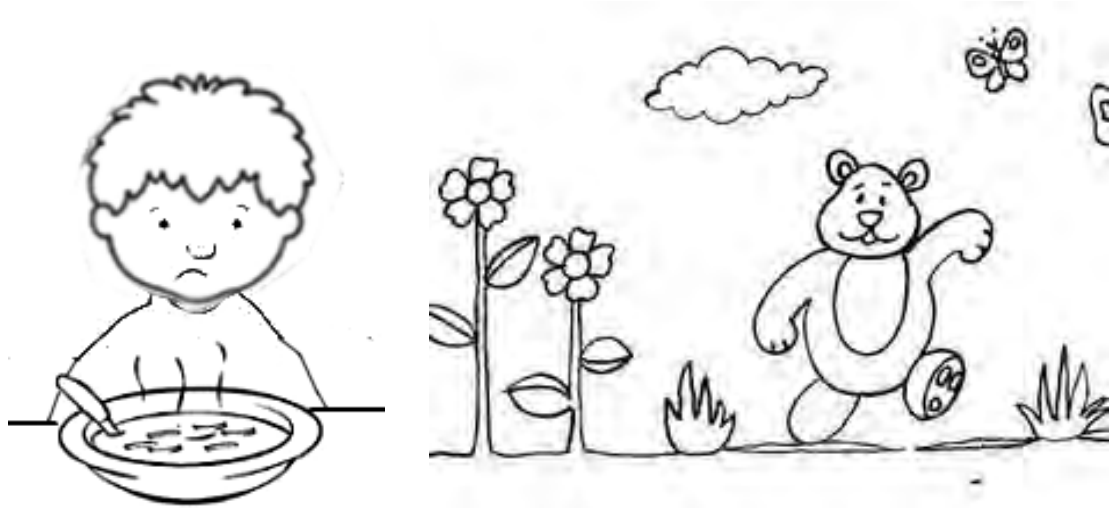

El oso se pasea.

Susi y su oso.

El sapo al sol.

La sopa sosa.

al el il ol ul



El sol.



El pulpo.



La sal.

as es is os us



El as.

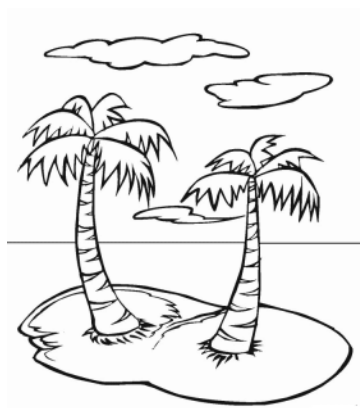

La isla.



Los pies.

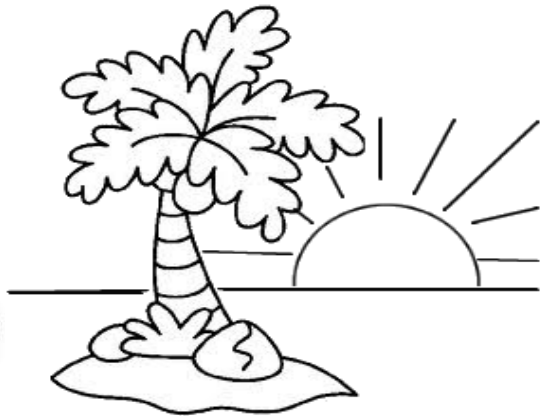
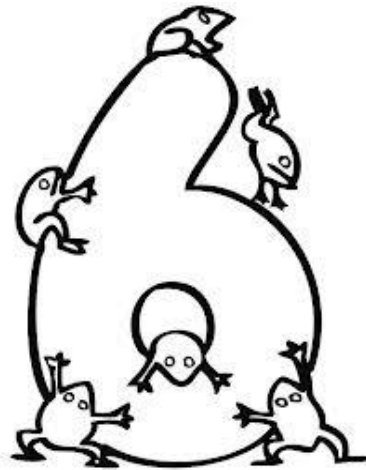

El sol y la isla.

Luis lee solo.

Seis sapos.

Pepe sala la salsa.

M m

ma me mi mo mu

Ma Me Mi Mo Mu



mamá



mesa

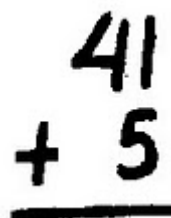

suma

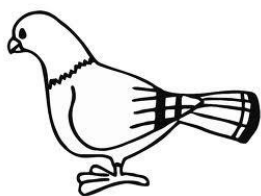

paloma



muela



miel



mapa

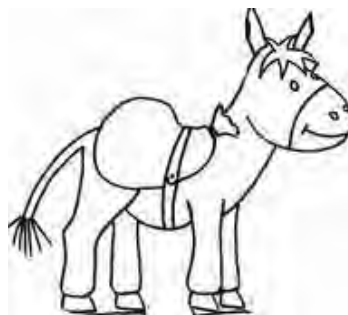

mula



amapola



Mamá se asoma.

¡Mi muela mala!

Amelia amasa la masa.

La mula y las amapolas.

T t

ta te ti to tu

Ta Te Ti To Tu



tomate

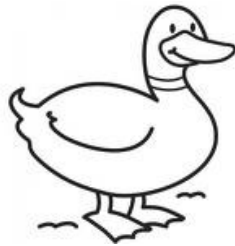

pato



moto



Tomás



lata

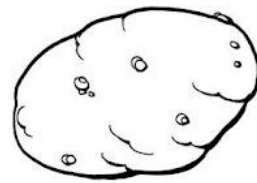

patata



seta



pito



maleta

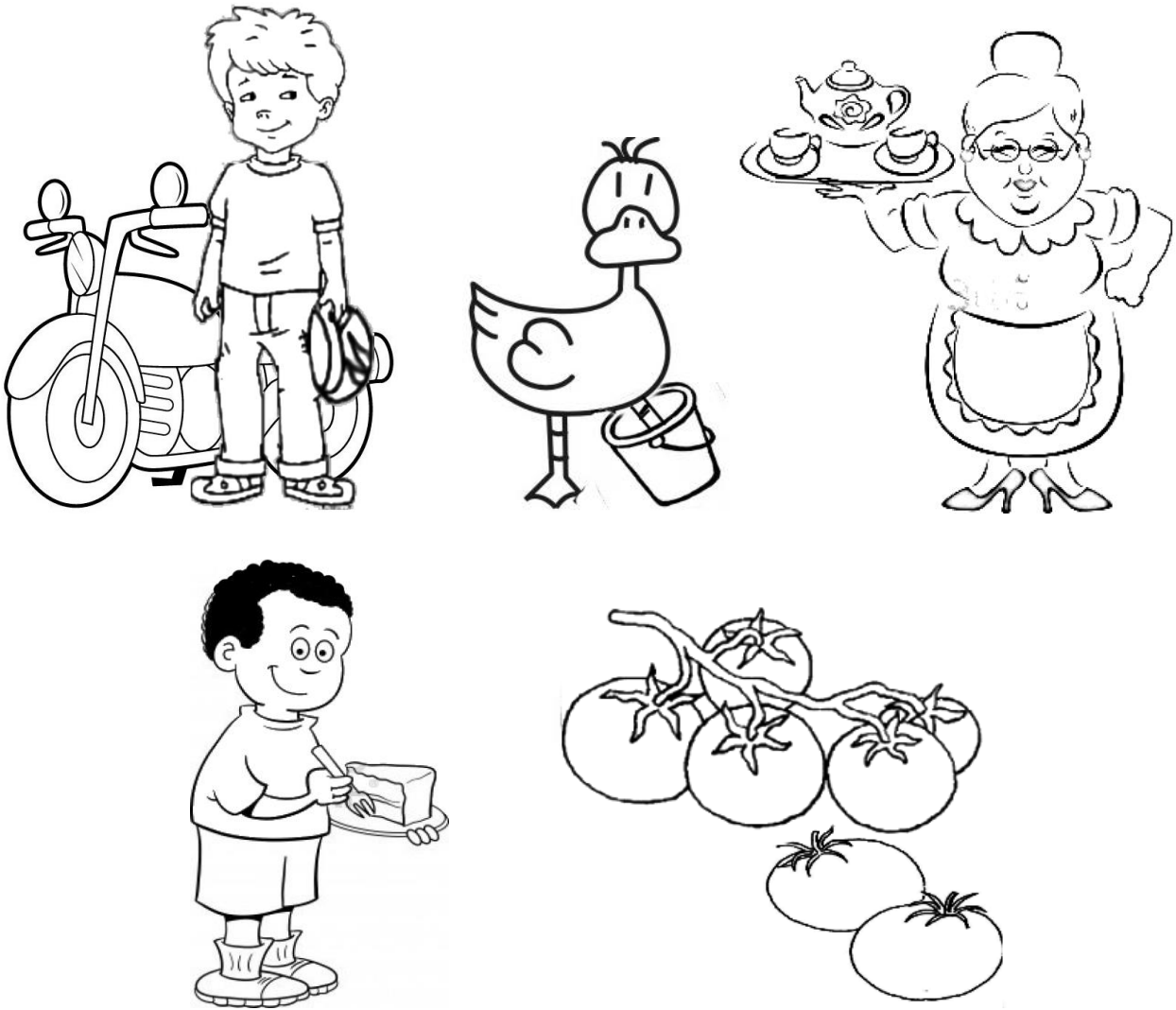

Siete tomates.

La tía Maite puso el té.

Mateo toma pastel.

El pato metió la pata.

Tomás y su moto.

N n

na ne ni no nu

Na Ne Ni No Nu



nene



nata



luna



mano



piano

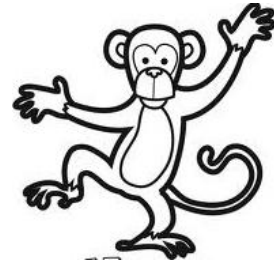

mono



notas



lana

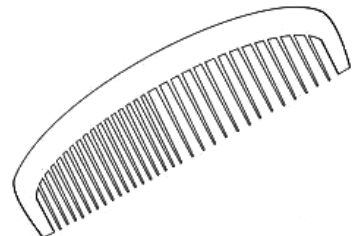

peine



Ana se sienta al piano.

Suenan las notas.

El enanito patina.

Natalia peina su melena.

Sale la luna.

El juego de las sombras



luna

león



pies

pino

paloma

nota



seta

olas

pala

lupa



maleta

polo



El juego de las sombras

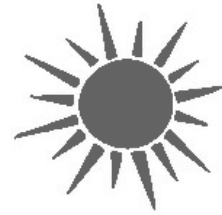

pato

moto

mano

muela

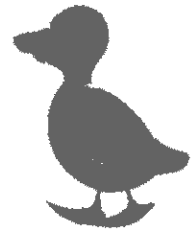

seis

mono



sol

sopa



peine

ele



alas

pulpo



D d

da de di do du
Da De Di Do Du



Un dedo.

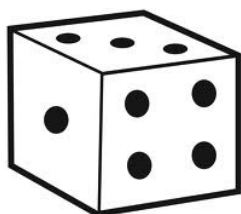

Un dado.



Las monedas.



El dos.



El nido.



Una tostada.



Un duende.



La sandía.

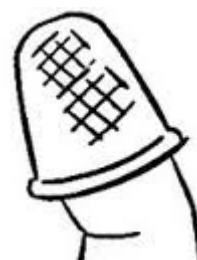

El dedal.

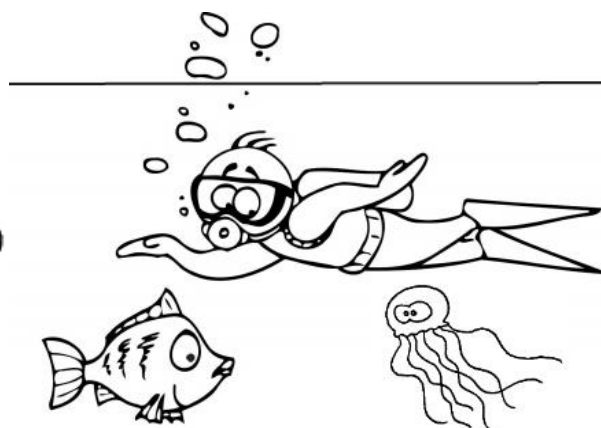
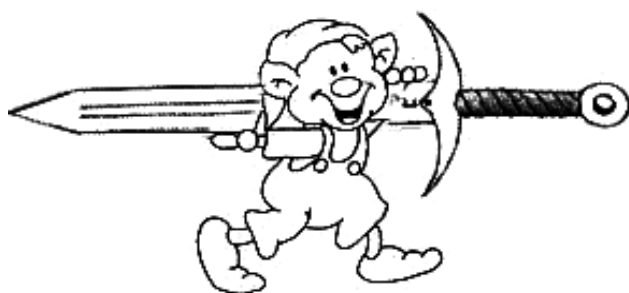

El soldado saluda.

A Daniel le duele la espalda.

La medusa me da miedo.

Un nido en el olmo.

El duende tiene una espada.

R r

ra re ri ro ru

Ra Re Ri Ro Ru



La rosa.



Una rana.

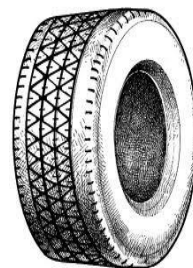

Una rueda.



El ratón.

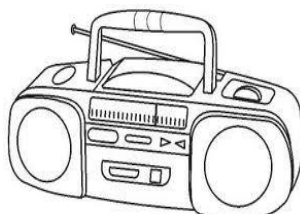

La radio.

$$\begin{array}{r} 7 \\ -2 \\ \hline 5 \end{array}$$

La resta.

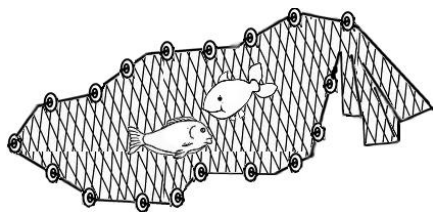

Una red.



Ramón

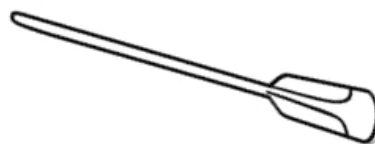

Un remo.

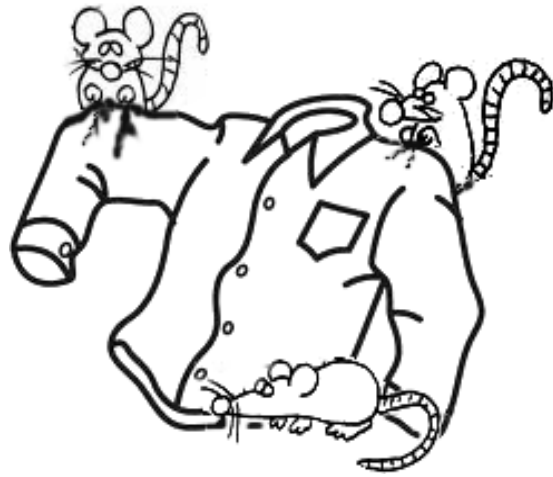
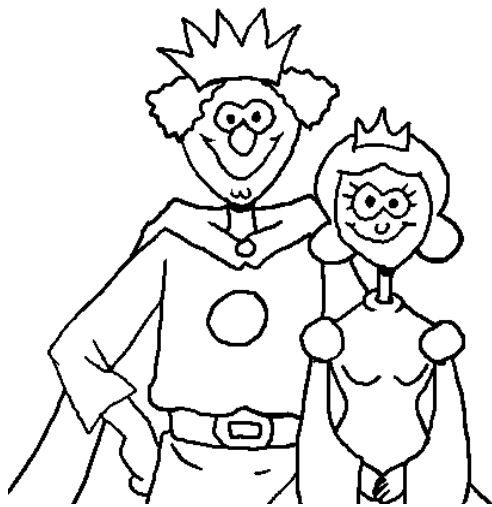

Esa rueda tiene radios.

Reme se rie.

Los ratones roen la ropa.

Ramón rema en el río.

Un rey y una reina.

an en in on un

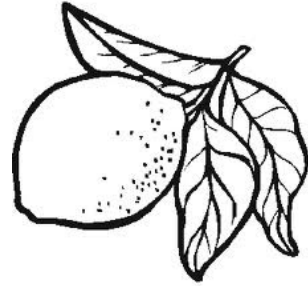
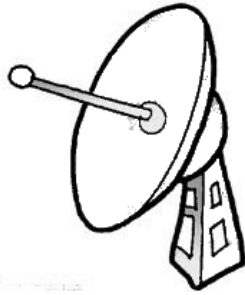

Una manta. La antena. Un limón.

ar er ir or ur

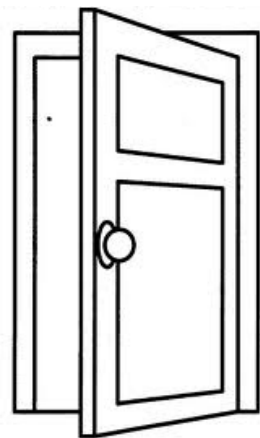
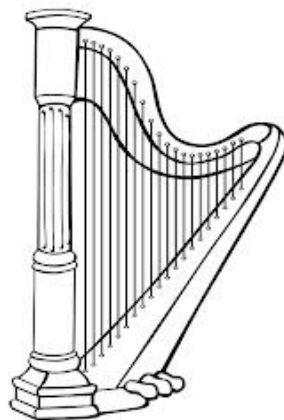
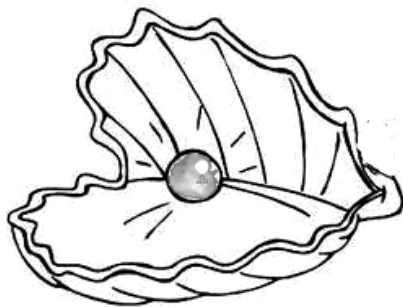

Una perla. El arpa. La puerta.

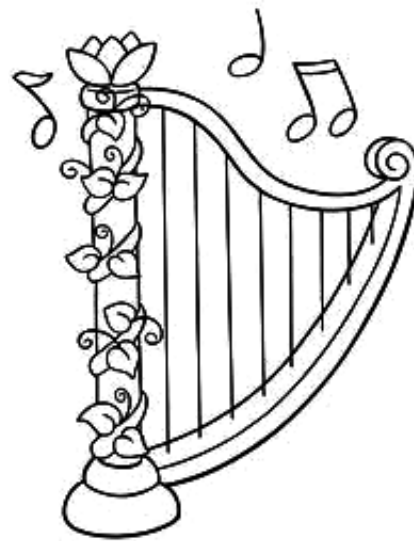

Un arpa muy adornada.

El oso panda muerde la rama.

Antonio es pintor.

Marta tiene pendientes y
pulseras de perlas.

F f

fa fe fi fo fu

Fa Fe Fi Fo Fu

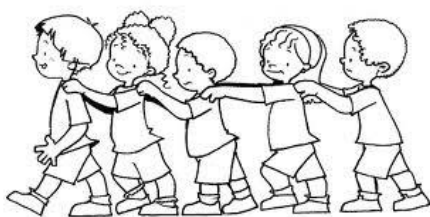

La fila. El teléfono. Una foto.



Un sofá. La mofeta. Una familia.

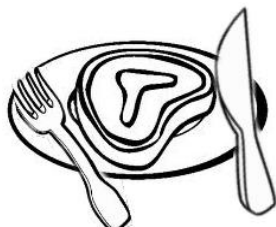

Un filete. La falda. El fantasma.

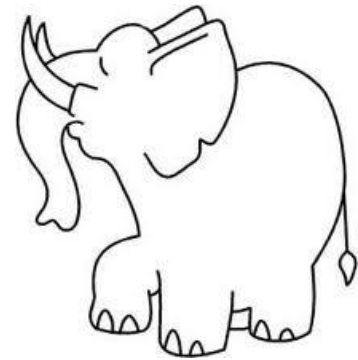

El fantasmita se asustó.
Una paloma en la fuente.
Felipe olió la mofeta.
El elefante es lento.
Rafa fue a la fiesta.

Ca co cu



El casco.



El pescado.

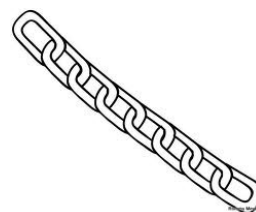

La cadena.

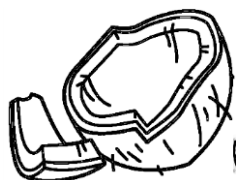

Un coco.



Una canoa.



Una cometa.



El camión.

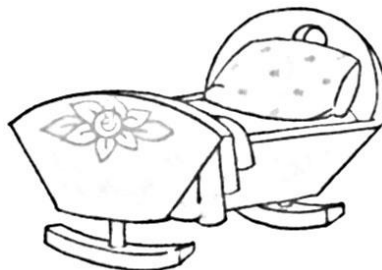

La cuna.



La camisa.



Una casa.



Los sacos.

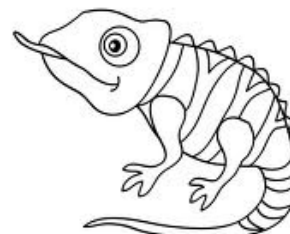

Un camaleón.



El romano tiene casco y escudo.

Nico lee cuentos de miedo.

Las focas comen pescado.

Carlos pescó un calamar enorme.

El café está caliente.

Que qui

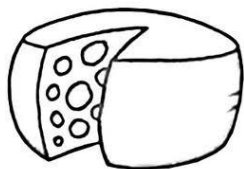

queso

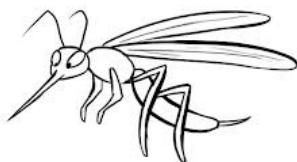

mosquito



esquiador

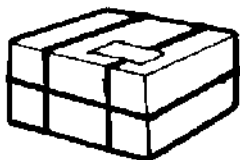

paquete



quesitos

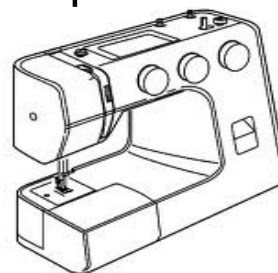

máquina



maniquí



esquimal

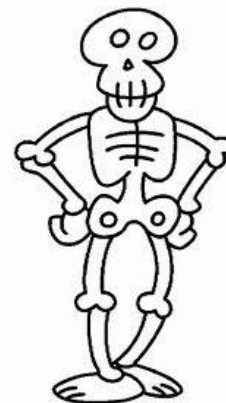

esqueleto



quimono



etiqueta



equipo



Paqui cose a máquina.

Quique tiene un quimono.

Un estanque con patos.

Ese esqueleto no da miedo.

Mi equipo es campeón.

El juego de las sombras

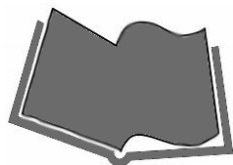

dos



mosquito



esquiar

dado



cuento

casa



delfín

teléfono



esqueleto

rana



arpa

cometa



camiseta

rey

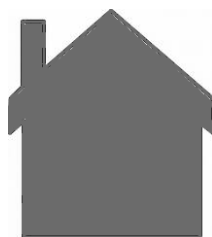
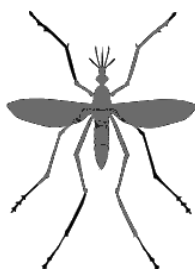

El juego de las sombras

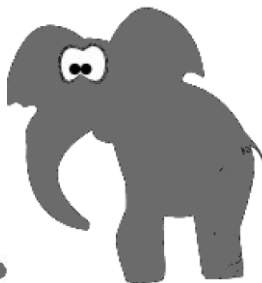

foca

falda



paquete

espada



medusa

café



elefante

esquimal



rueda

nido

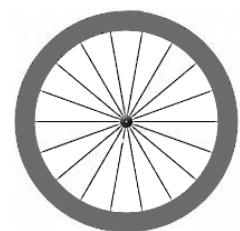

fantasma

rosa



camión

ratón

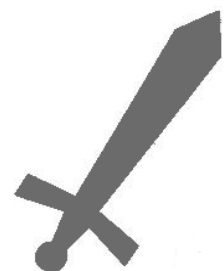
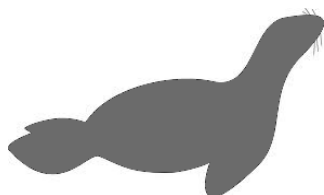

H h

ha he hi ho hu

Ha He Hi Ho Hu



Un hada.



Un helado.



El humo.

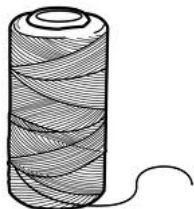

El hilo.

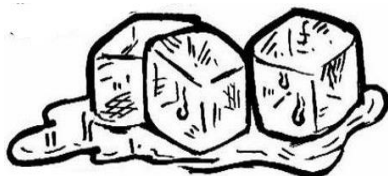

El hielo.



Un hueso.

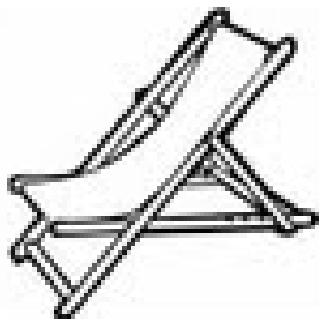

Una hamaca.

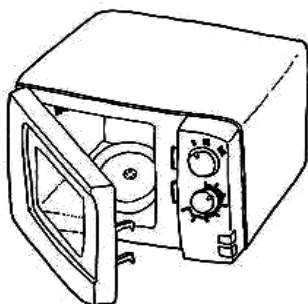

El horno.

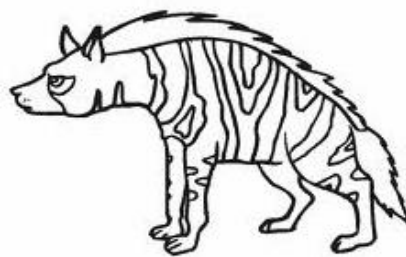

La hiena.

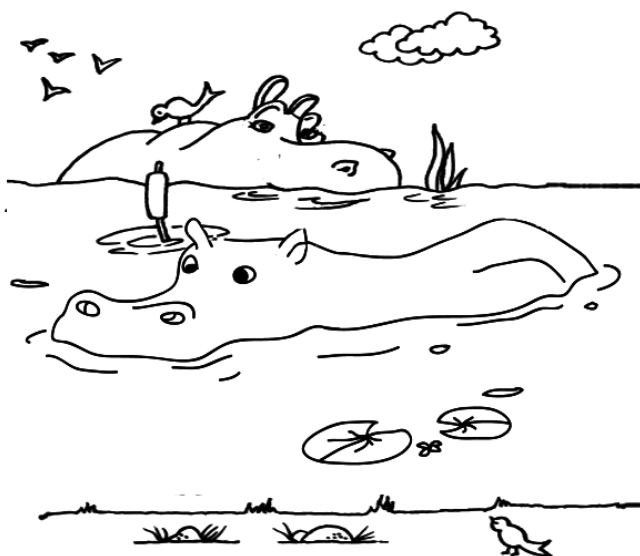

El panadero hornea los panes.

Hay hipopótamos en ese río.

Héctor y Elfi lamen el helado.

¡Es estupendo patinar en el hielo!

Ch ch

cha che chi cho chu

Cha Che Chi Cho Chu

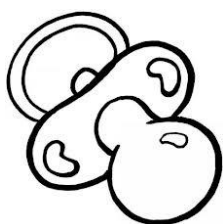

El chupete. El chocolate. Una hucha.

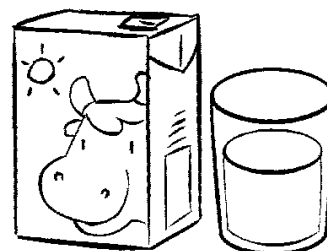
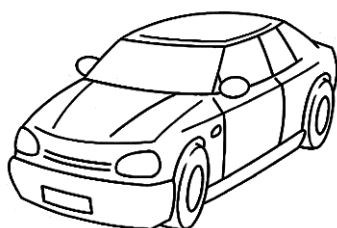

Un coche. La noche. La leche.

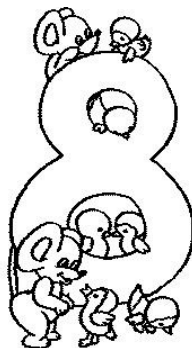

Una mochila. El ocho. La chaqueta.



En la esquina han chocado dos coches.

Faltan ocho fichas del parchís.

Chelo echa monedas en su hucha.

Choni se ducha todas las noches.

En mi mochila hay un estuche y muchas cosas más.

arra erro orri urro arre



Un perro.



Un puerro.



El serrucho.



Un corro.



Una torre.



La Tierra.

ari era iru oro ure

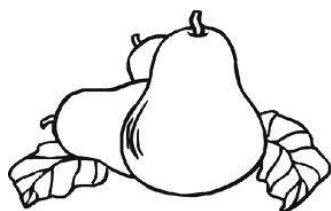

Las peras.



El caracol.

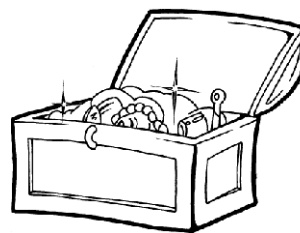

Un tesoro.

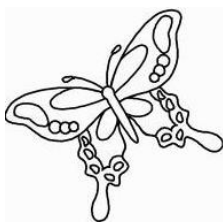

Una mariposa.



Una careta.



El loro.

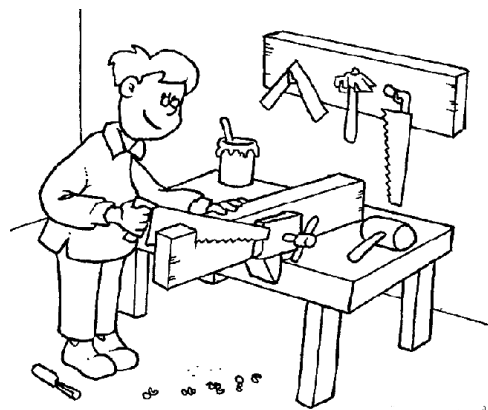
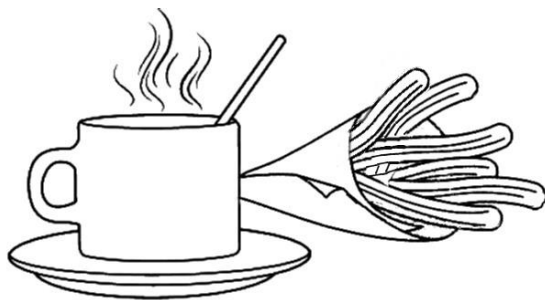

Quiero churros y chocolate para merendar.

La torre Eiffel está en París.

Está hecha de hierro.

La perra mira a sus cachorros.

El carpintero sierra la madera.

B b

ba be bi bo bu

Ba Be Bi Bo Bu



El bebé. Un búho. Unos botones.



La abuela. El balón. Un bombero.

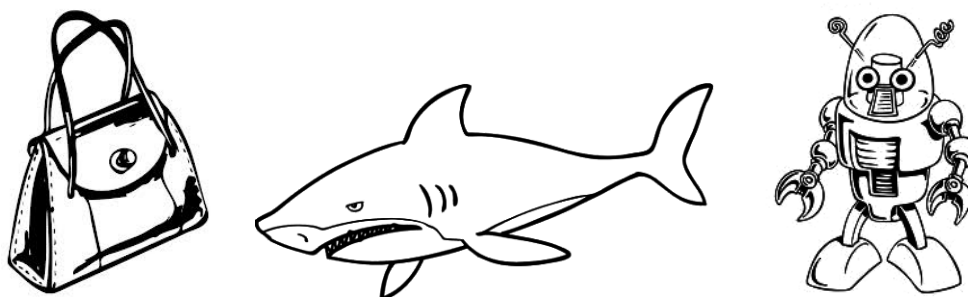

El bolso. Un tiburón. El robot.



Belén tiene unas botas y un bolso bonitos.

El cubo de la basura huele mal.

El abuelo tiene un bastón.

El barco tiene una bandera pirata.

Roberto toca bien la batería.

V v

va ve vi vo vu

Va Ve Vi Vo Vu

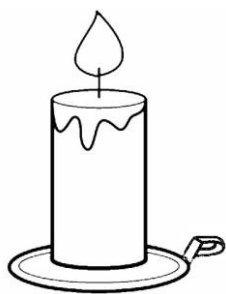

La vela.



Los huevos.

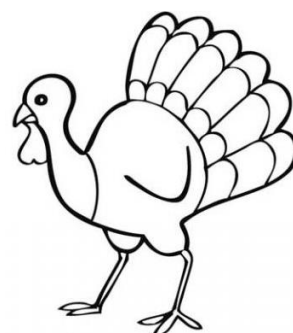

Un pavo.



Unas violetas.



El avión.



Una avispa.

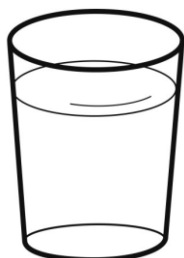

El vaso.

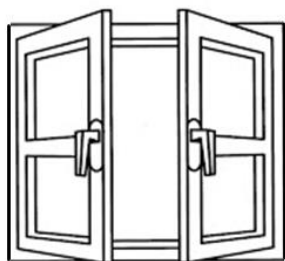

La ventana.

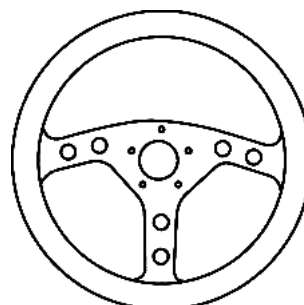

Un volante.

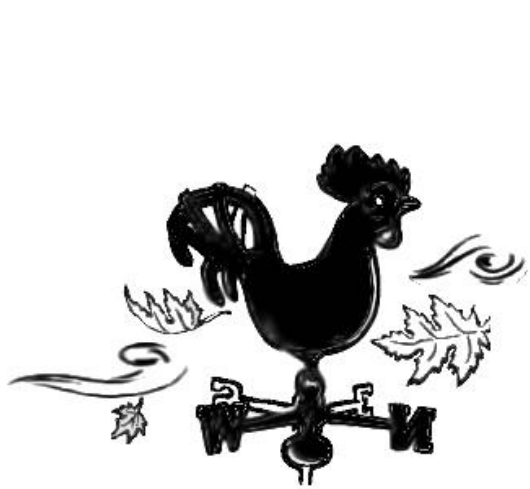
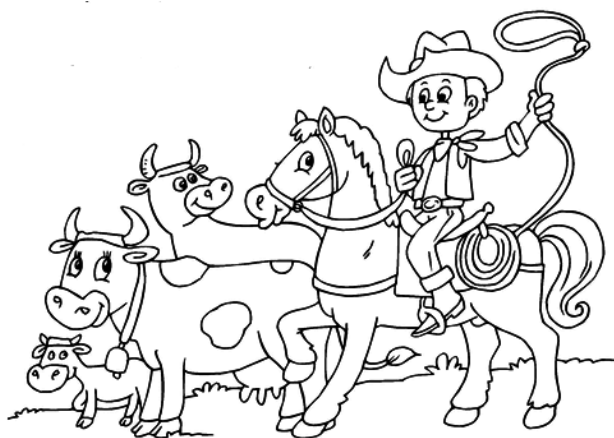
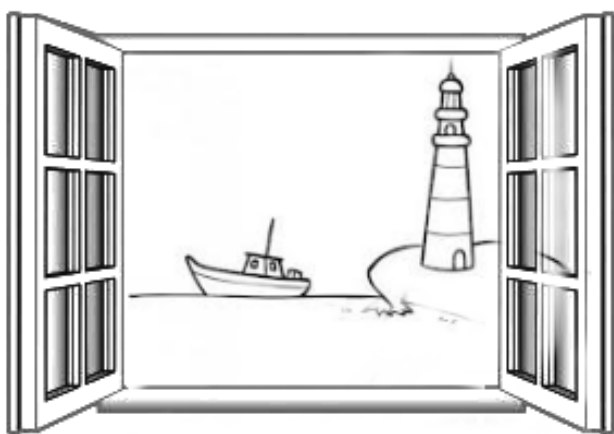

Verónica tiene un vestido nuevo.

Desde la ventana se ve el mar.

El viento mueve la veleta.

El vaquero cuida de las vacas.

¡Hay una avispa en el vaso!

El juego de las sombras

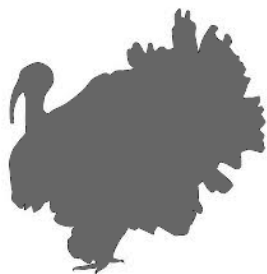

torre

hueso



barco

labios



helado

pera



ocho

volcán

vela

chupete



hipopótamo

ducha



avión

pavo

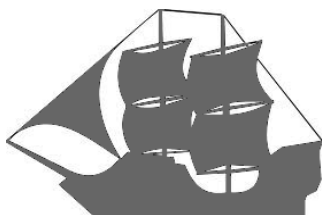

El juego de las sombras

9



veleta

búho



coche

humo



chaqueta

mochila

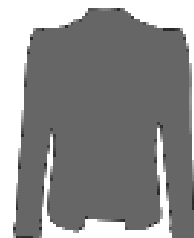

violetas

botón

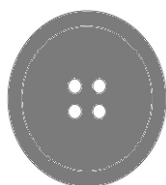

perro

nieve

hada

salchicha

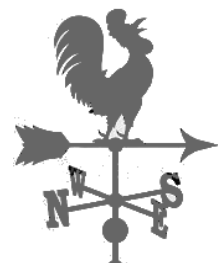

biberón

mariposa

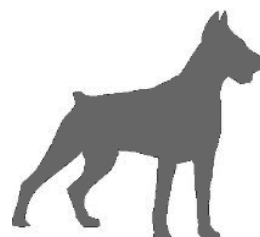

Z z

za

zo

zu

Za

Zo

Zu

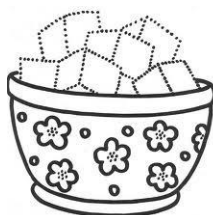

Los zapatos.

El azúcar.

Las tazas.



Un lazo.

La calabaza.

Una pizarra.

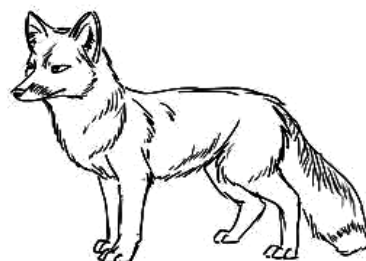
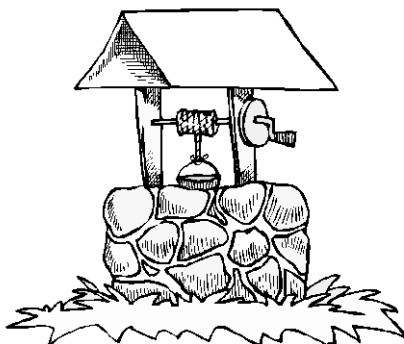

Las zanahorias.

Un pozo.

Un zorro.



Zacarías tiene el pelo rizado y Paz
se ha puesto lazos en la cabeza.

Mamá tiene unos zapatos azules.

Lorenzo saca cartas del buzón

El zorro está rezando porque el
cazador le amenaza.

ce ci Ce Ci

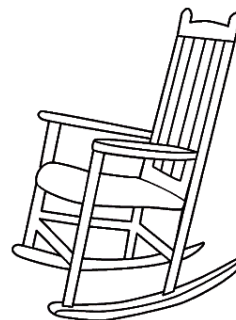

La cesta. Una ciudad. La mecedora.

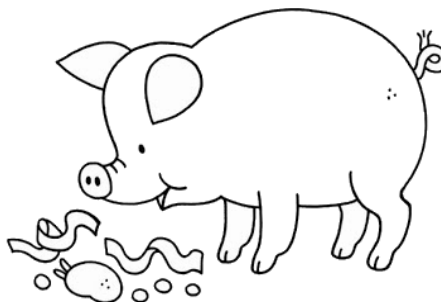
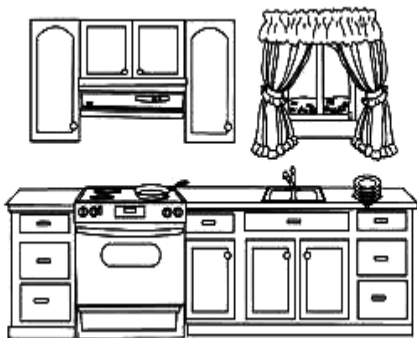

Una cocina. El cerdito. La maceta.

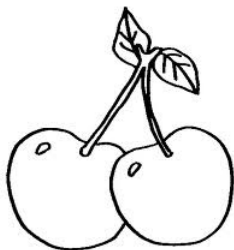

Las cerezas. Una pecera. Los calcetines.

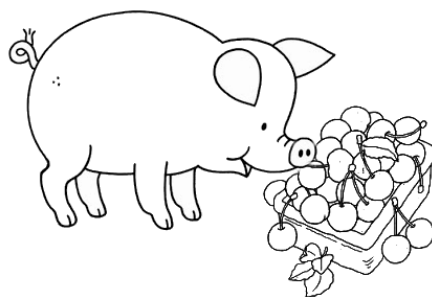

El cerdito se come las cerezas.

Cinco cisnes nadan.

El cocinero hizo pescado para cenar.

En la casa hay una luz encendida.

Cerca de la piscina hay césped.

G g

ga

go

gu

Ga

Go

Gu

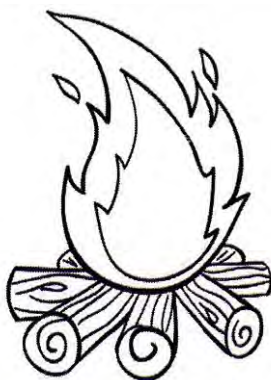

El fuego.

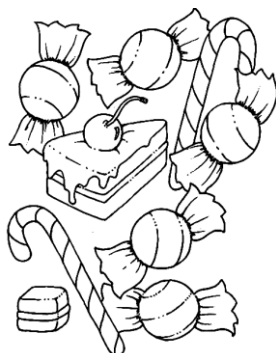

Las golosinas.

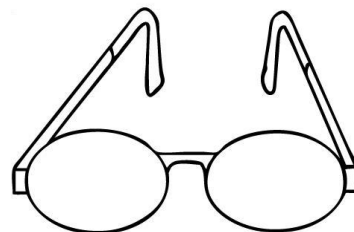

Las gafas.

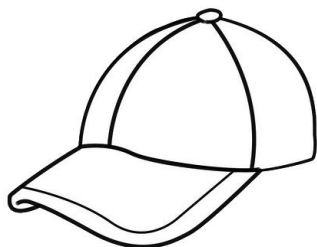

Una gorra.



Un gorrión.



Una goma.

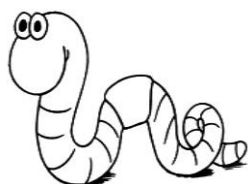

Un gusano.



Los guantes.



La lechuga.



Olga está muy guapa con sus gafas nuevas.

A ese gusanito le gusta la lechuga.

Los abuelos tienen arrugas.

La bufanda, los guantes y el gorro de lana son ropa de invierno.

que qui Gue Gui



Una guitarra.

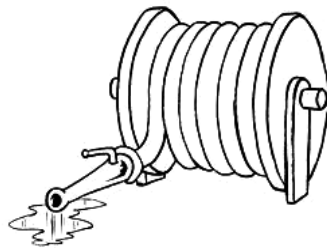

La manguera.

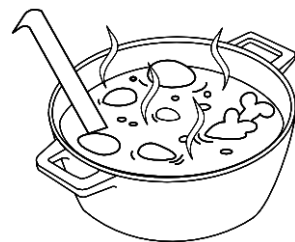

El guiso.



Los espaguetis.



El águila.

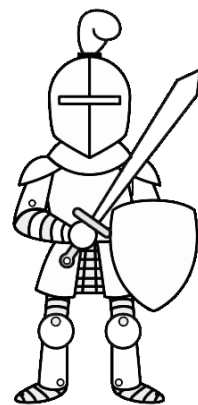

Un guerrero.



Una hoguera.

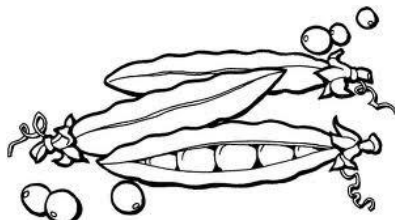

Los guisantes.



Las quindas.

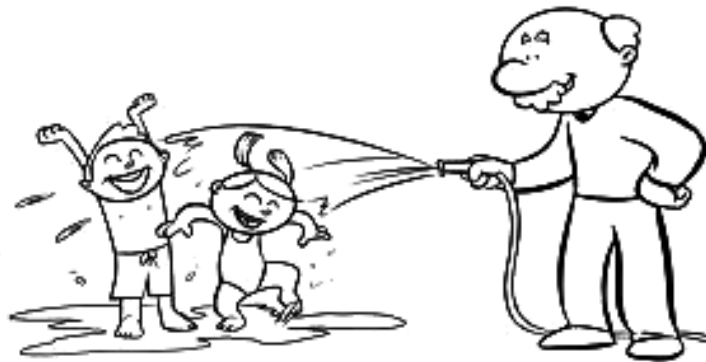

El guepardo persigue a la gacela.

Cuando hace calor el abuelo nos riega con la manguera.

Mamá hace un guiso con guisantes y verduras. Después adorna con quindas el pastel de merengue.

Ll ll

lla lle lli llo llu

Lla Lle Lli Llo Llu



Una llave.

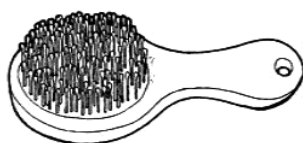

El cepillo.

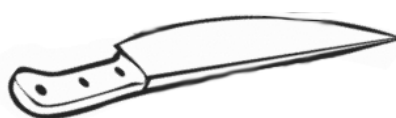

Un cuchillo.

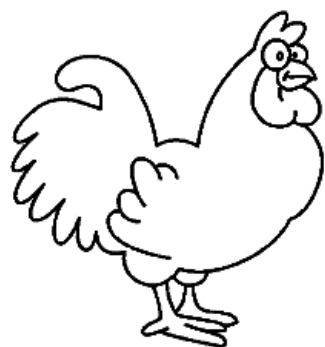

La gallina.



Una botella.



La paella.



Un castillo.

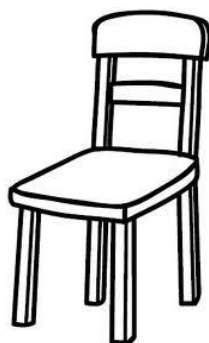

Una silla.

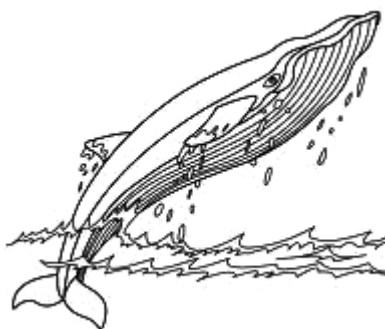

Una ballena.

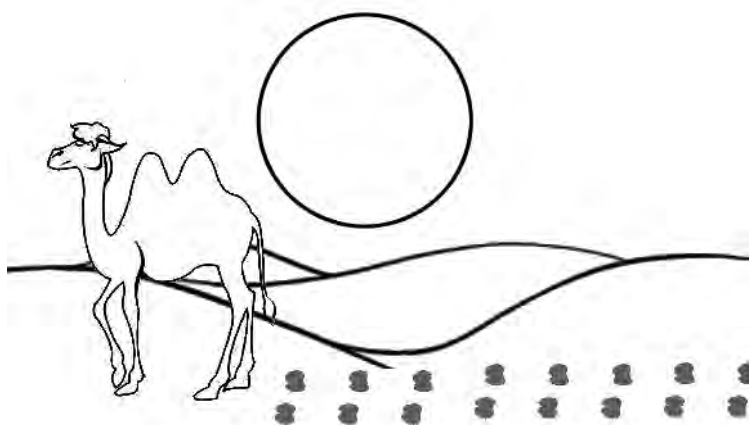
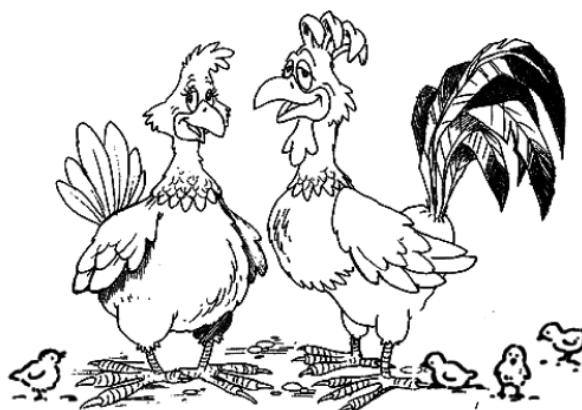

En la arena se ven las huellas del camello.

Guille se ha caído de la silla y llora.

El gallo y la gallina cuidan de sus pollitos.

Llevo un llavero en el bolsillo.

El juego de las sombras



llave

taza

cinturón

gusano



quisantes

maceta



silla

águila

sillón

gorra



querrero

zapato



zanahoria

gallo



El juego de las sombras

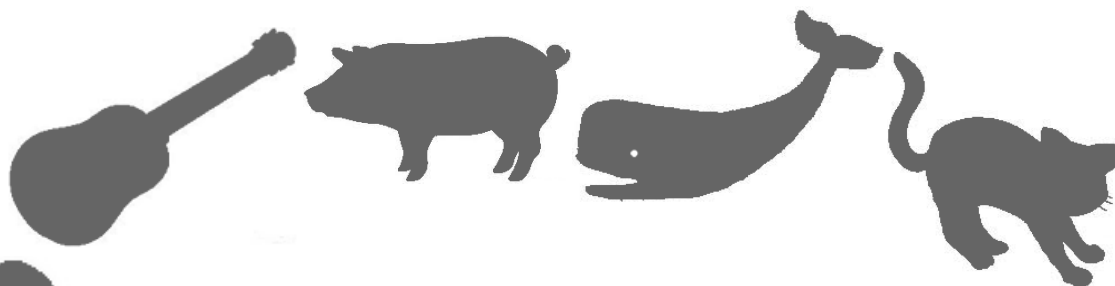

ballena

lazo

cerezas

cisne

gafas

cesta

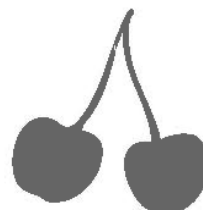

guitarra

botella



gato

manzana

calabaza

huella



castillo

cerdo

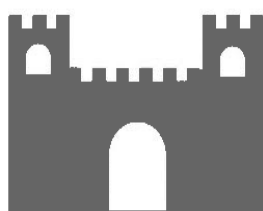

Y y

ya ye yi yo yu

Ya Ye Yi Yo Yu



El yoyó.



Un yogur.



Una escayola.



Un rayo.



El payaso.



La yema.

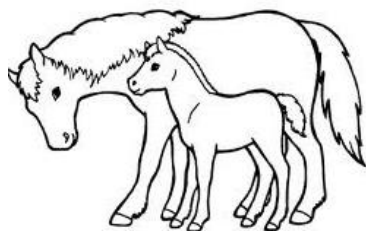

La yegua.

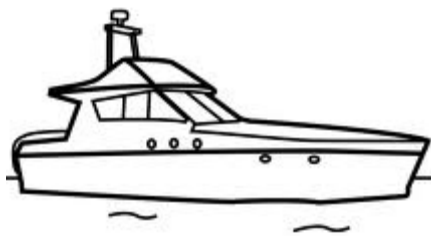

Un yate.



El desayuno.

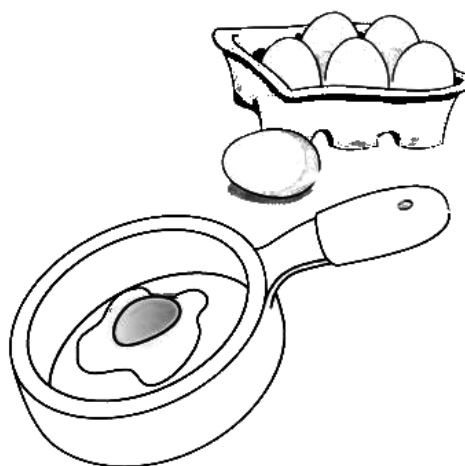

El payaso se pasea en la yegua.

Yeray desayuna galletas y yogur.

Yolanda hace yoga.

La yema del huevo es amarilla.

J j Ge gi

ja je ji jo ju

ge gi

Ja Je Ji Jo Ju

Ge Gi



Los ojos.

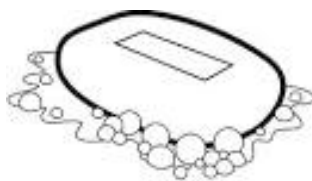

El jabón.



Un conejo.

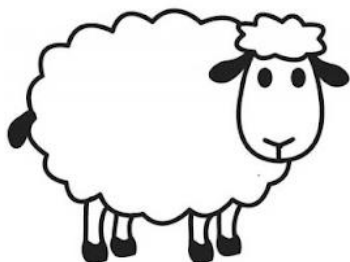

Una oveja.



La jaula.



Dos jirafas.



El geranio.



Los gemelos.



Un gigante.



Ángela hace el equipaje, viajará en avión a Gerona.

Los pájaros están en la jaula y el conejito está fuera.

En la fiesta del colegio Julia se viste de gitana y Jorge de general.

En el jardín hay geranios y girasoles.

Ñ ñ

ña ñe ñi ño ñu

Ña Ñe Ñi Ño Ñu

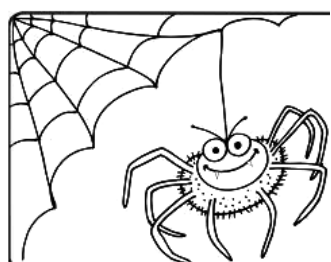

La araña. Una muñeca. Un moño.

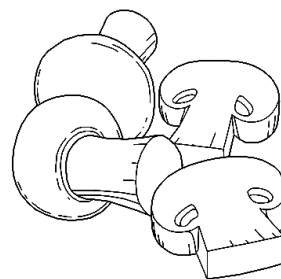

Las castañas. El puño. Champiñones.

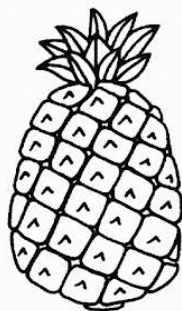

Una señal. La piña. El baño.



Está lloviendo mucho, la castañera vende castañas calentitas.

Esa niña juega con su muñeca.

En otoño, la ardilla recoge piñas, bellotas y castañas.

El cerdito albañil terminó su cabaña.

X x

xa

xe

xi

xo

xu

Xa

Xe

Xi

Xo

Xu

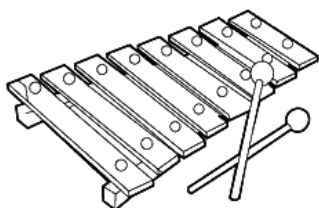

xilófono



taxi



excavadora



boxeador



saxofón



exámen



experimento

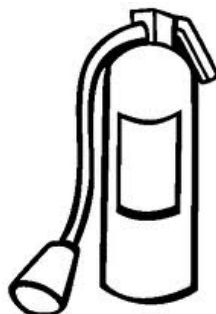

extintor



excursionistas

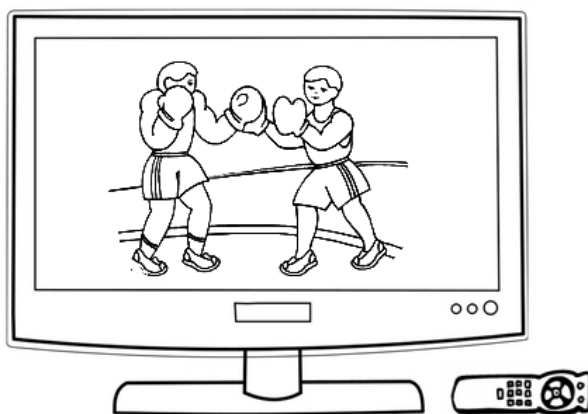

El bombero Félix usa el extintor.

En la tele dieron un combate de boxeo.

Máximo y sus amigos van de excursión al monte.

Alex hace experimentos.

güe güi

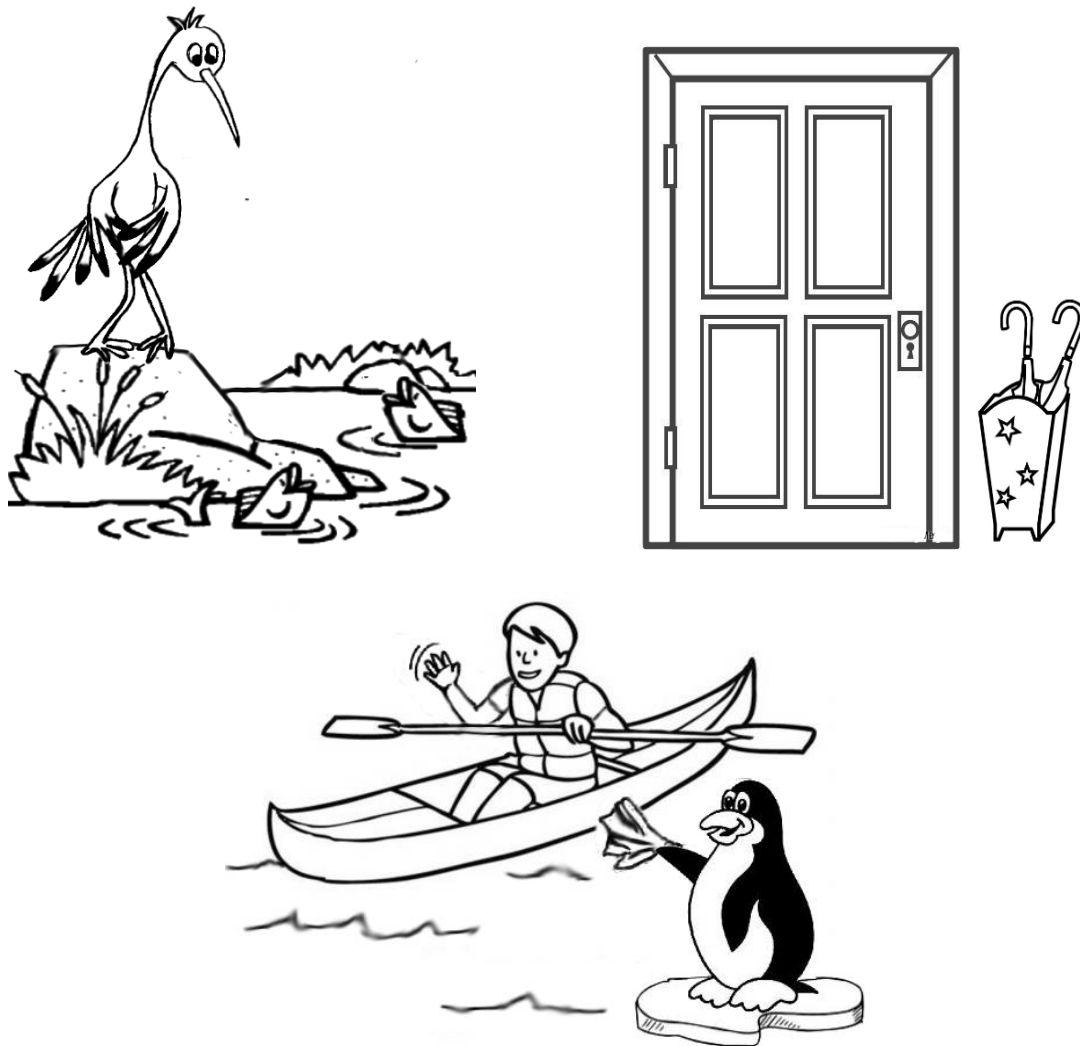

El piragüista saludó al pingüino de la orilla.

A la cigüeña le da vergüenza bañarse.

En la puerta de casa tenemos un paraguero.

K ka ke ki ko ku

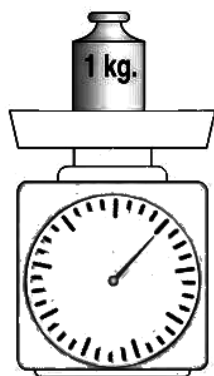

kárate kilo koala bikini

Katia tiene un bikini de rayas.

W wa we wi wo wu

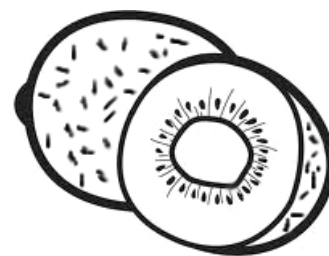

sandwich windsurf kiwi

Walter pone ketchup en su sandwich.

El juego de las sombras

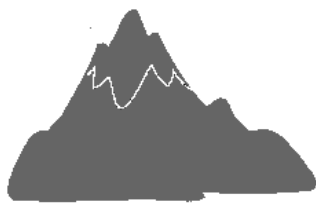

extintor

ajo

kárate

jirafa

sacofón

cañón



piragüista

rayo



yogur

gel



montaña

kiwi

jinete

cigüeña

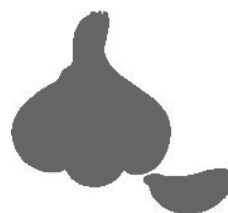
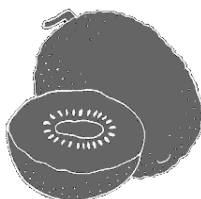

El juego de las sombras

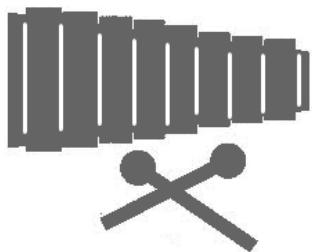

payaso

pingüino

windsurf

xilófono

bikini

jaula



pájaros

yoyó

paraguero

yegua

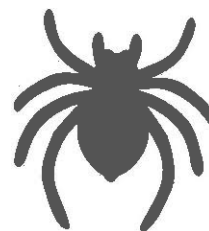

joyas

muñeca



kilo

araña

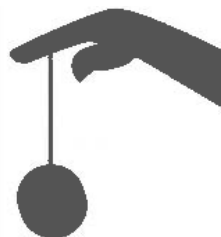
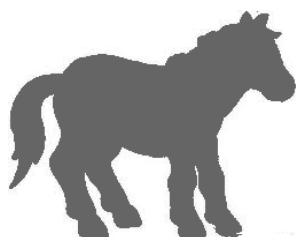

pra pre pri pro pru

par per pir por pur



princesa



precio



premio

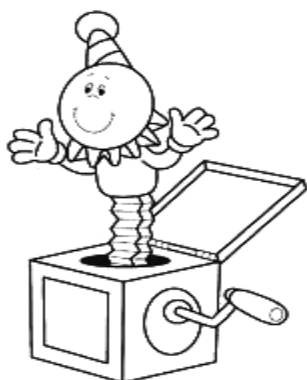

sorpresa



compra

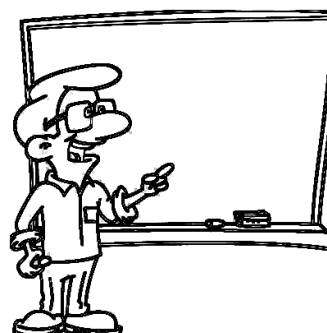

profesor



prohibido

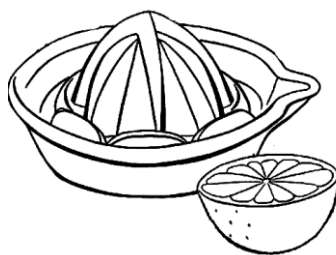

exprimidor



prismáticos

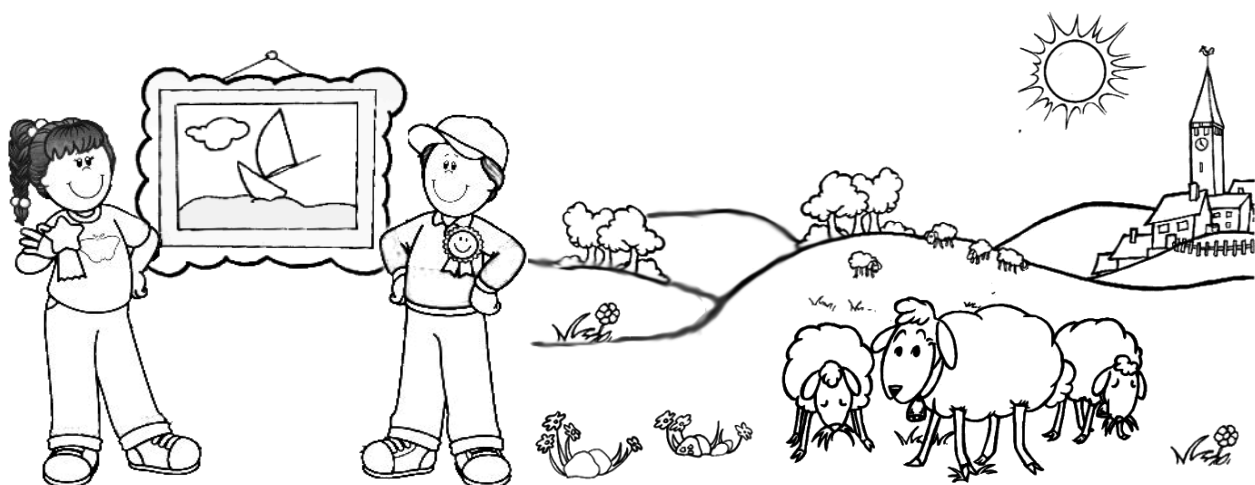

Juan no es el primero de la fila.

En primavera el prado está precioso.

A mis primos les dieron un premio por su dibujo.

Pruden es muy caprichoso.

pla ple pli plo plu

pal pel pil pol pul

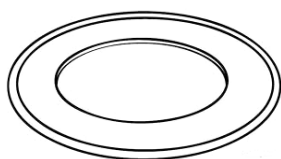

plato

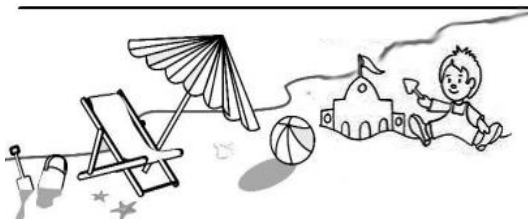

playa

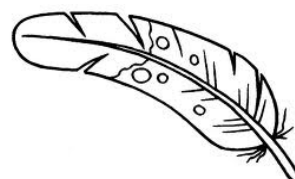

pluma

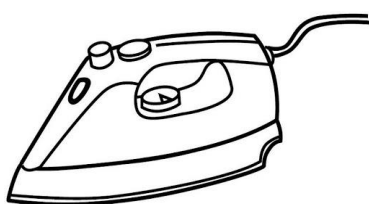

plancha



aplauso



plátano

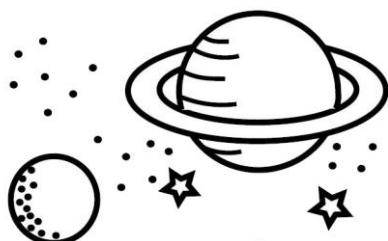

planeta

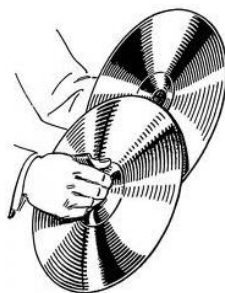

platos



planta

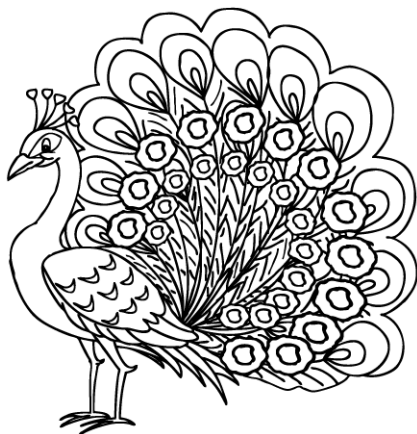

En esa playa hay palmeras.

El pavo real tiene un precioso plumaje.

Papá lava los platos y los pone en el
platero.

El arquitecto dibuja los planos de la
casa

bra bre bri bro bru

bar ber bir bor bur

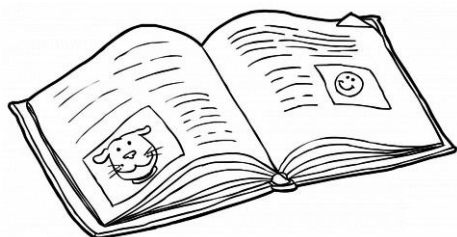

libro



abridor



sombrero

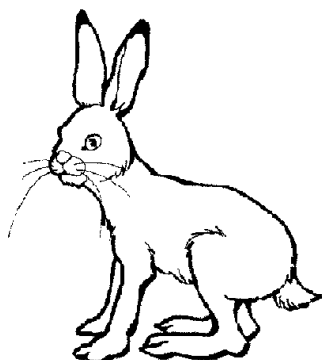

liebre



abrigo



bruja



brocha

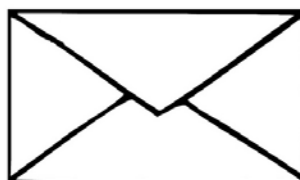

sobre

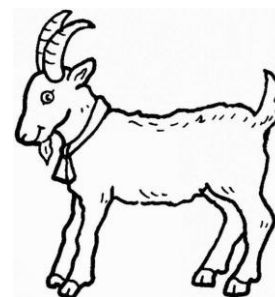

cabra



La bruja se prueba sus sombreros.

Bárbara tiene un brillante en su anillo.

Bruno y Brígida brindan en la fiesta.

Esa cabra hace equilibrios.

bla ble bli blo blu

bal bel bil bol bul



mueble



roble



tabla



blusa



pueblo

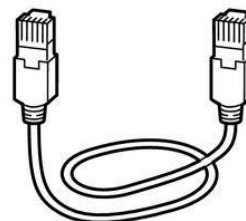

cable



niebla

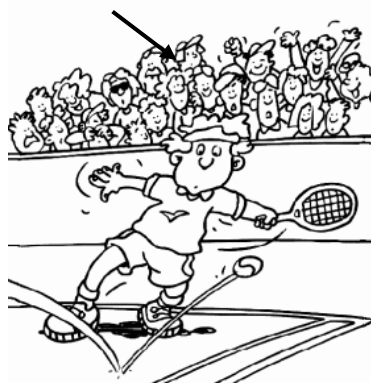

público



hablar

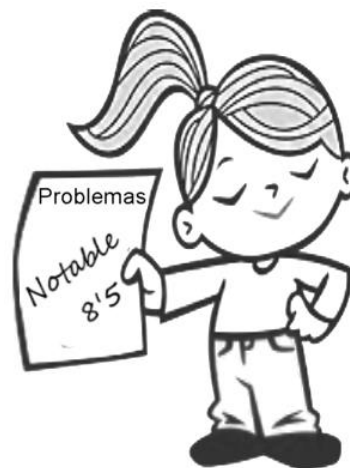
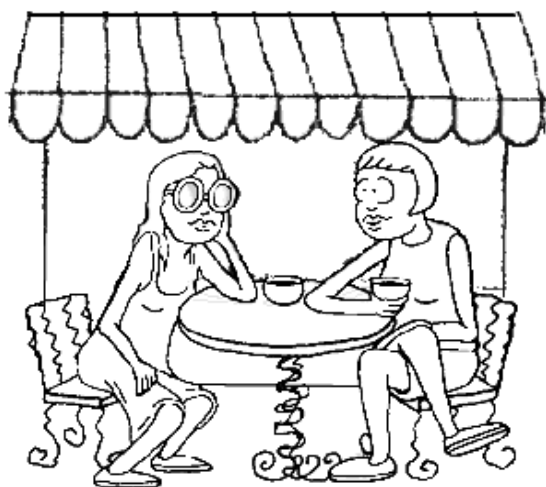

Isabel y Blanca hablan y toman café.

El público aplaudió en el concierto.

Maribel tiene un notable en los problemas de matemáticas.

Los niños están sacando libros de la biblioteca.

cra cre cri cro cru

car quer quir cor cur

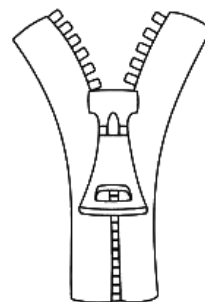

cromos

escribir

cremallera

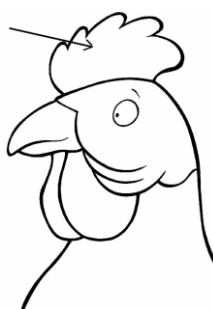
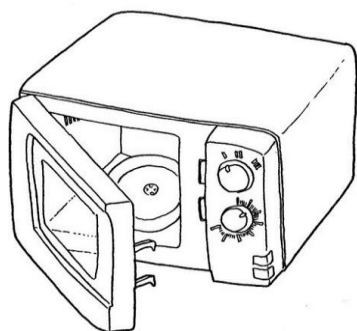

microondas

cresta

crisantemos

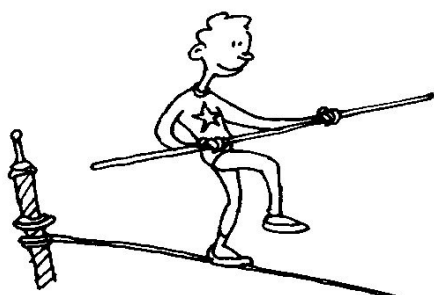

acróbata

crema

micrófono



Cristóbal y su mamá quieren cruzar la calle.

Cristina es secretaria en su oficina.

El mono Crispulo hace acrobacias en el circo.

Mari Cruz colecciona cromos.

cla cle cli clo chu
cal quel quil col cul

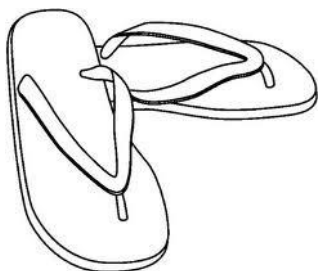

chancas

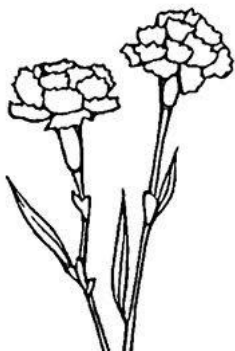

claveles



chicle



bicicleta



ancla

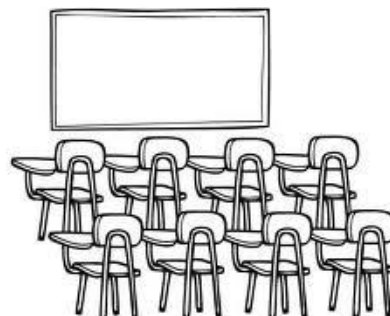

clase

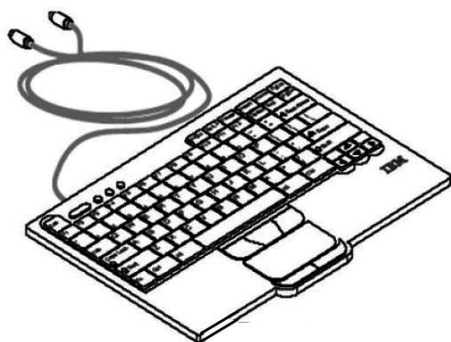

teclado



clarinete



clínica

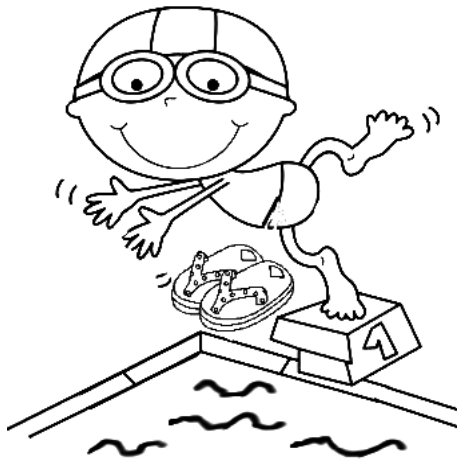
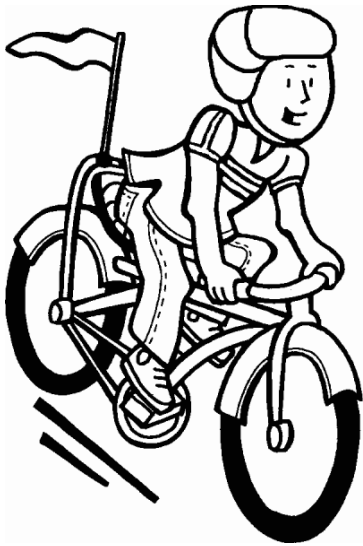

Claudio lleva gorro y chanclas a la clase de natación.

Hay claveles en el jarrón de cristal.

En clase no se puede comer chicle

Clara siempre se pone el casco de ciclista.

gra gre gri gro gru
gar quer quir gor gur

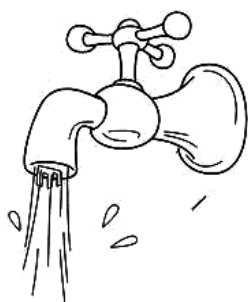

grifo



grillo

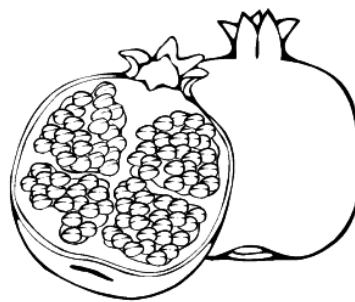

granada

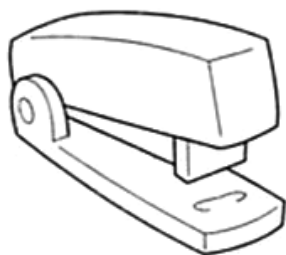

grapadora

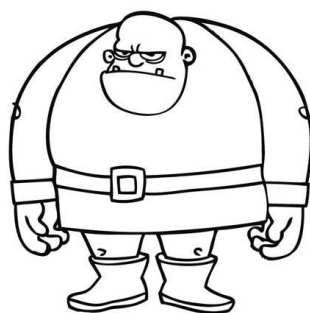

ogro

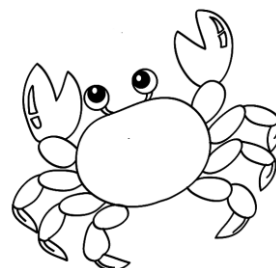

cangrejo

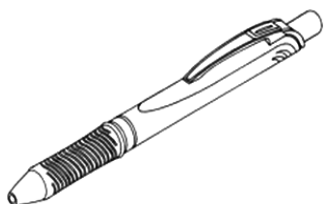

bolígrafo

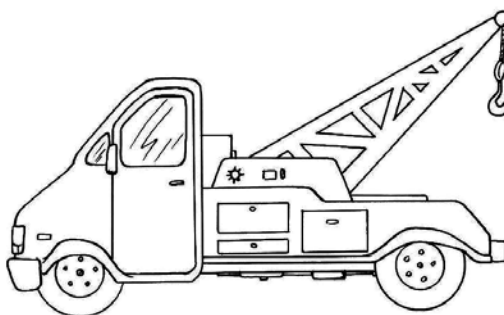

grúa



gritar

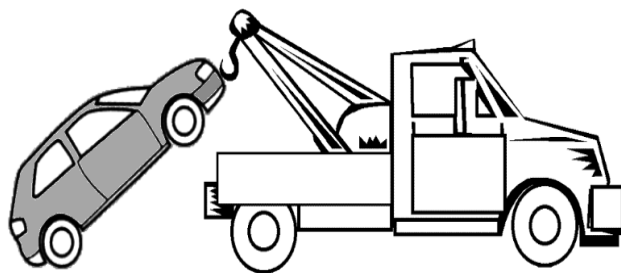

Greta y su hijo recogen granadas en la granja.

La grúa se llevó el coche gris.

Ese hombre fotografía un grupo de tigres.

El ogro salió de la gruta gruñendo.

gla gle gli glo glu
gal quel quil gol gul

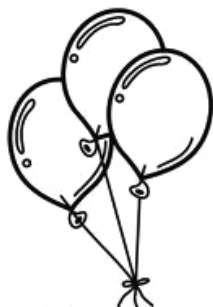

globos



iglesia



gladiador



jungla



gladiolo



glotón

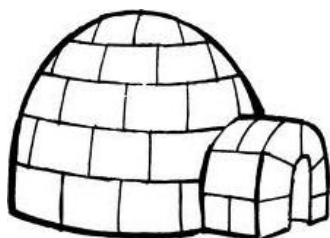

iglú

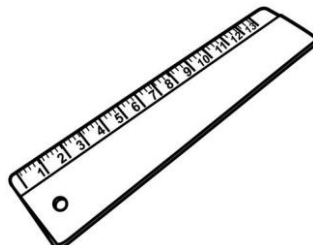

regla



jeroglífico



Gladiis voló en globo hasta Inglaterra.

El zapatero arregla los zapatos.

Un gladiador se enfrentó al tigre.

Ese esquimal hace su iglú con bloques de hielo.

fra fre fri fro fru

far fer fir for fur

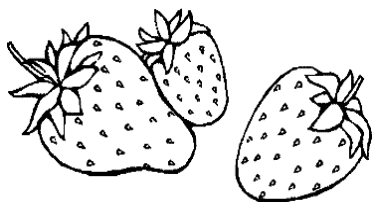

fresas



fregadero



frasco

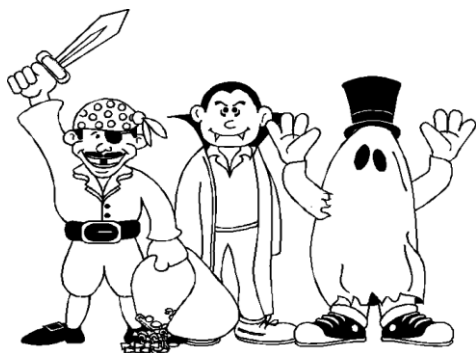

disfraces



fregona



frigorífico

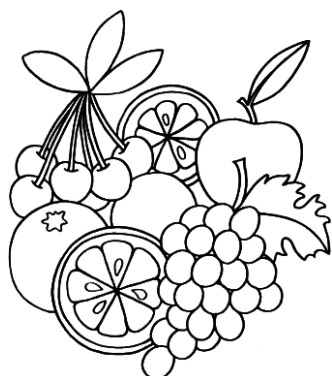

frutas

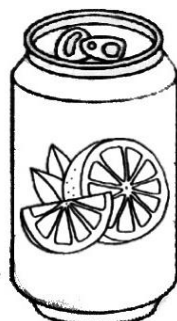

refresco



frío

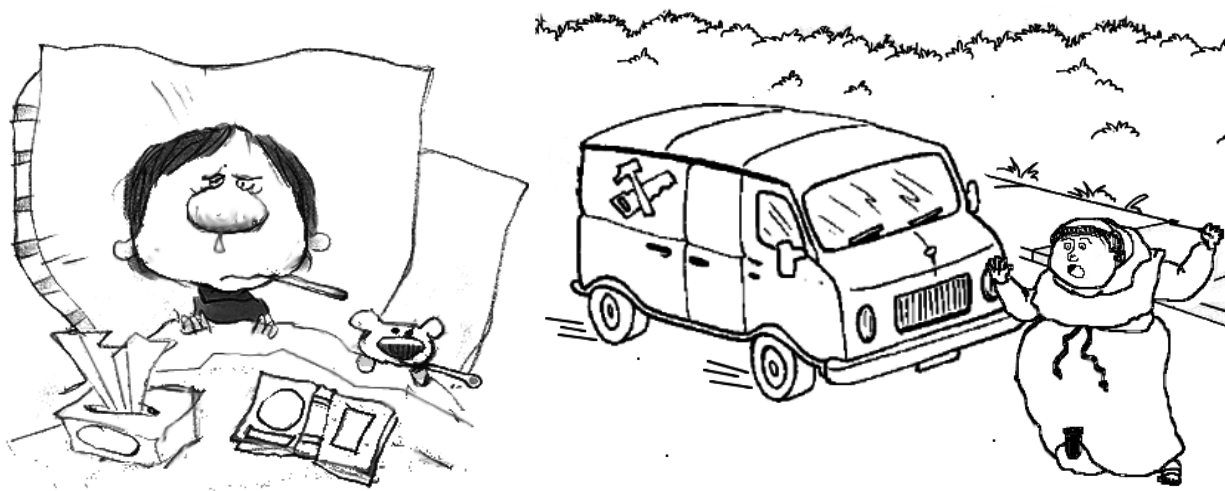

África sacó del cofre su disfraz de enfermera.

Alfredo se ha resfriado y tiene fiebre.

La furgoneta frenó para no pillar al fraile.

Francisco bebe agua muy fresquita.

fla fle fli flo flu

fal fel fil fol ful



flecha



flexo

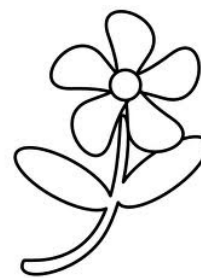

flor



coliflor



flauta



flan



flequillo



flotador



florero



Flavio infla globos para la fiesta.

Papá me enseña a preparar flan.

Fran hace flexiones para estar en forma.

El hada Florinda toca la flauta vestida de flor.

tra tre tri tro tru

tar ter tir tor tur



estrellas

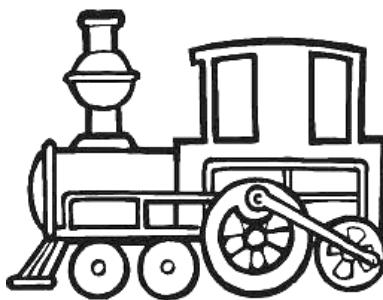

tren

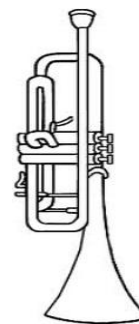

trompeta

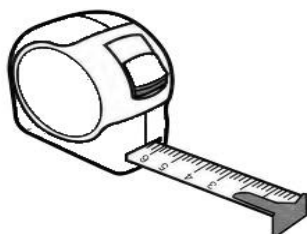

metro

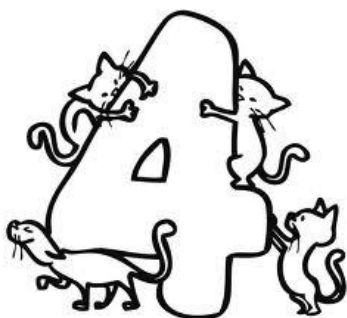

cuatro

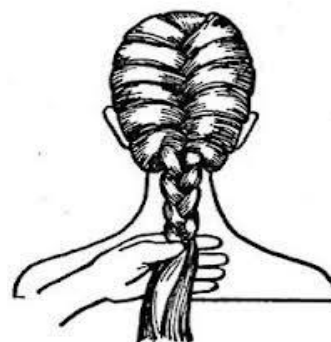

trenza

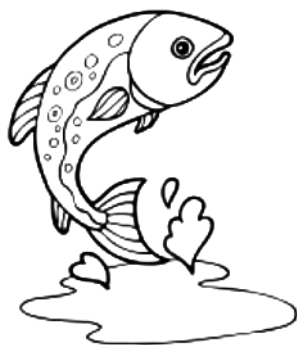

trucha

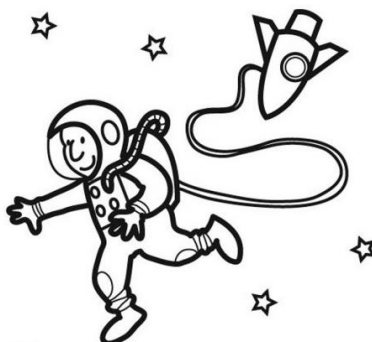

astronauta

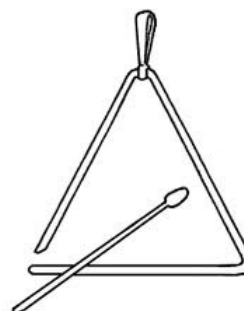

triángulo

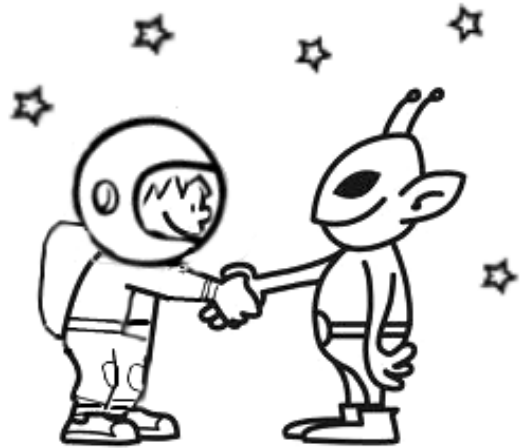
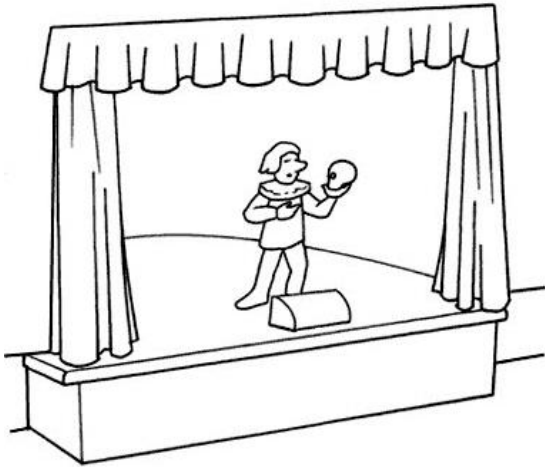

El sastre cose trajes para hombres.

Patricio es actor de teatro.

Trini trepa por el tronco del árbol
para rescatar a su gato.

En el espacio el astronauta encontró
un extraterrestre.

dra dre dri dro dru

dar der dir dor dur

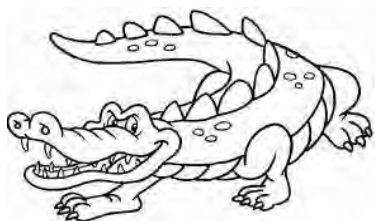

cocodrilo

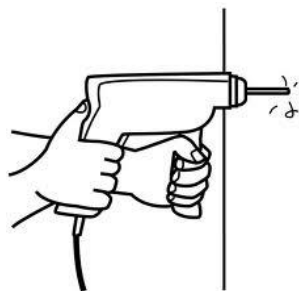

taladro

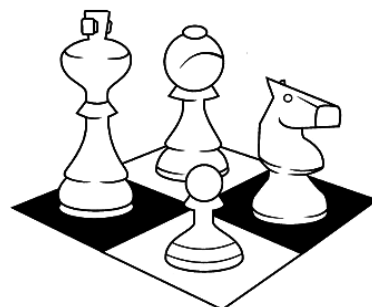

ajedrez



golondrina



ladrón

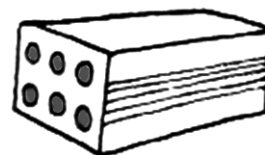

ladrillo



dragón

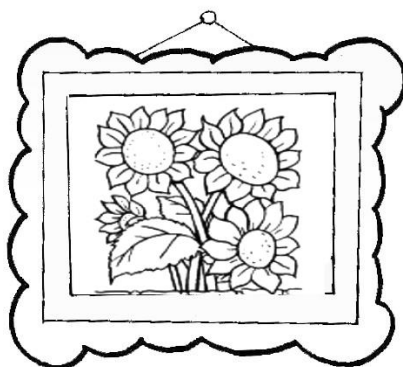

cuadro



piedra

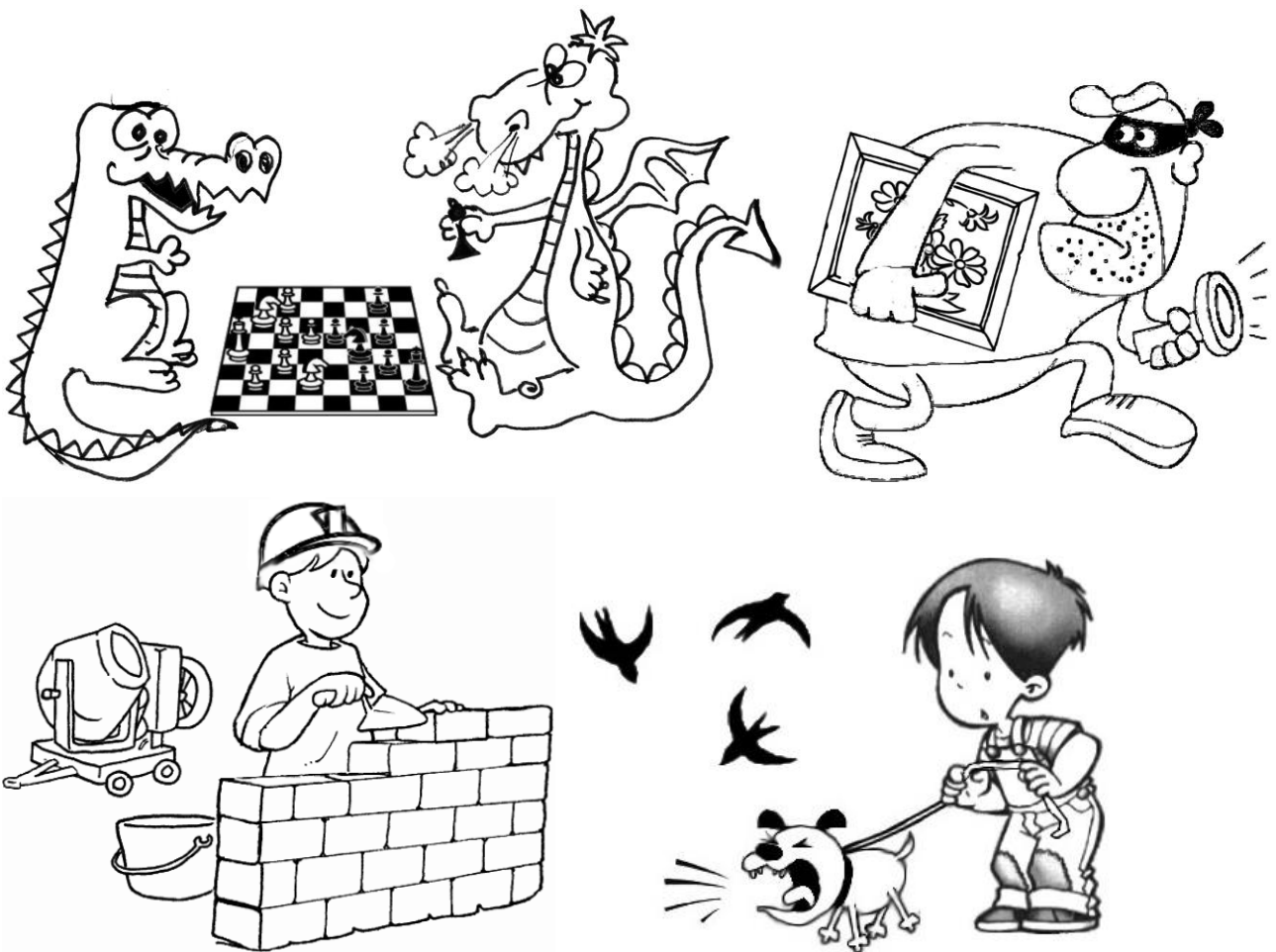

Pedro hace un muro con ladrillos.

El dragón y el cocodrilo juegan al ajedrez.

El perro de Isidro ladra a las golondrinas.

Ese ladrón pretende robar un cuadro.

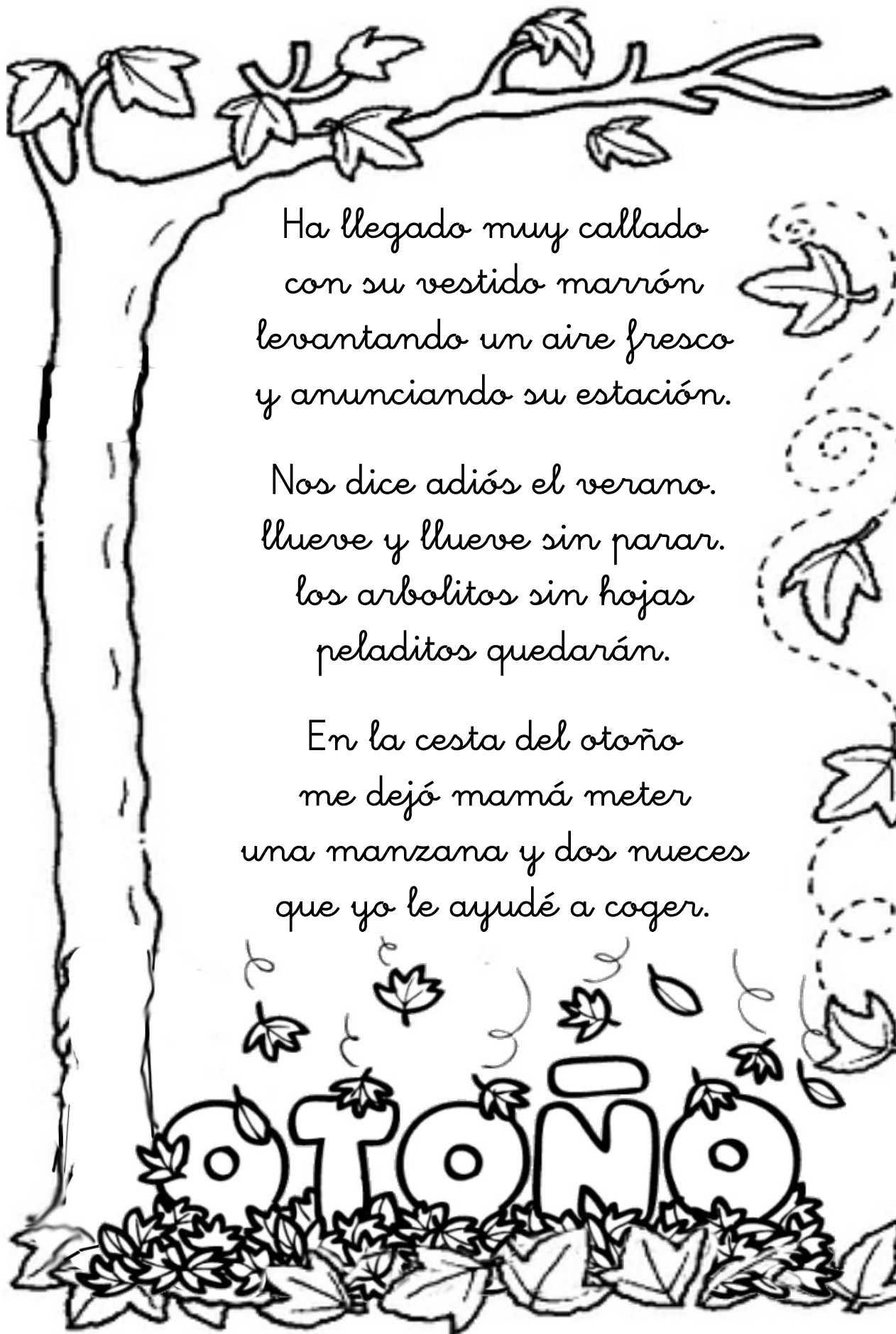

Ha llegado muy callado
con su vestido marrón
levantando un aire fresco
y anunciando su estación.

Nos dice adiós el verano.
llueve y llueve sin parar.
los arbolitos sin hojas
peladitos quedarán.

En la cesta del otoño
me dejó mamá meter
una manzana y dos nueces
que yo le ayudé a coger.



El invierno comenzó
muy temprano esta mañana
y ha cubierto todo el parque
con una blanca nevada.

Con la nieve que cayó,
un gorro y una bufanda,
hemos hecho un gran muñeco
allí, junto aquellas casas.

Sopla que te sopla
llueve que te llueve,
montado en el viento
el invierno viene.





En esta maceta
que compró mamá
semillas de flores
yo voy a sembrar.

En su camita de tierra
descansa la semilla dorada;
algunas gotas de la lluvia
entraron a despertarla.

El sol se acercó un poquito,
le regaló su calor.

La semilla rompió su traje,
hizo fuerza... y se estiró.





¡Ya está aquí el verano!

¡Ya está aquí el calor!

Se acabó el colegio,
la tripita al sol.

Y ahora, como patos,
a nadar un rato.

Y ahora, como peces,
flotando otras veces.

El sol en el cielo,
la brisa del mar,
se asoman las olas
para saludar.

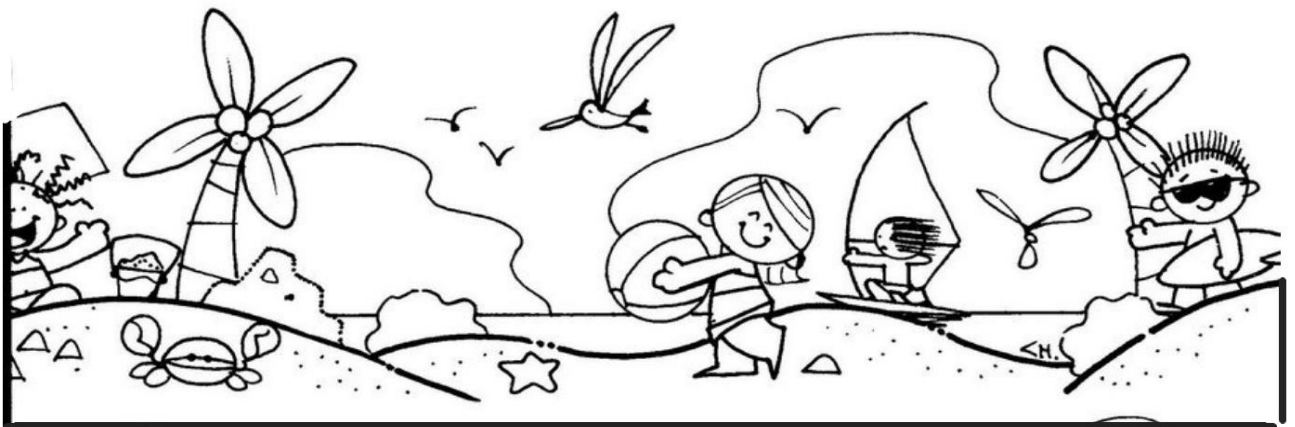

Despacito y buena letra,
que el hacer las cosas bien,
importa más que el hacerlas.

Antonio Machado

Son de abril las aguas mil.
Sopla el viento achubascado,
y entre nublado y nublado
hay trozos de cielo añil.
Agua y sol. El iris brilla.
En una nube lejana,
zigzaguea
una centella amarilla.

Era un niño que soñaba
un caballo de cartón.
Abrió los ojos el niño
y el caballito no vio.
Con un caballito blanco
el niño volvió a soñar;
y por la crin lo cogía...
¡Ahora no te escaparás!





La plaza tiene una torre,
la torre tiene un balcón,
el balcón tiene una dama,
la dama una blanca flor.

Ha pasado un caballero
-¿quién sabe por qué pasó?-,
y se ha llevado la plaza,
con su torre y su balcón,
con su balcón y su dama,
su dama y su blanca flor.

Textos: Ana Alonso Castelo

Ilustraciones: M^{ra} Dolores Fernández Seguí

M^{ra} Soledad Blanco Ramos

Josefa Pareja Sánchez

Coordinación y maquetación:

M^{ra} Dolores Fernández Seguí

Leo, leo... ¡El león!

“Leo, leo, el león” es un método de lectoescritura adaptado a las capacidades y situaciones sociales, culturales y económicas del alumnado que, en la actualidad, y prácticamente de forma generalizada, está escolarizado en los colegios de la Comunidad de Murcia, y más concretamente en

Cartagena y su comarca. El resultado es un nuevo material, una novedosa adaptada a necesidades concretas, tanto para quienes van a aprender con él, como para los docentes que se encuentran frente a situaciones tan concretas.

www.educarm.es/publicaciones

